



SISTEMAS PARA PORTAS DE CORRER

Sliding doors systems
Systèmes pour portes coulissantes

openspace[®]
sliding doors by GOSIMAT

CATÁLOGO
Catalogue

2025

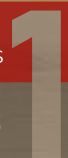

ÍNDICE | INDEX

- 3- Economia de espaço / *Space saving / Gain d'espace*
- 4- Características e Acessibilidades | *Features and Accessibilities / Caractéristiques et accessibilités*
- 5- Garantia OPENSAPCE | *OPENSAPCE Warranty / Garantie OPENSAPCE*
Norma EN1527 : 2013 | *Standard / Norme*

CAIXILHOS | *POCKET FRAMES / CONTRE-CHÂSSIS*

- 6- UNICO
- 8- UNICO XL
- 10- UNICO PLUS
- 12- UNIKIT
- 14- ENCONTRO
- 16- PARALELO WOOD
- 18- PARALELO GLASS
- 20- PARALELO WOOD PLUS
- 22- PARALELO GLASS PLUS
- 24- INVERSO

EASY KITS | *EASY KITS / EASY KITS*

- 26- STANDARD
- 28- ELEGANCE WOOD
- 29- ELEGANCE GLASS
- 30- RETRO
- 31- RETRO SLIM
- 32- RETRO MAXI
- 33- RETRO FOLD
- 34- STYLE WOOD
- 35- STYLE GLASS
- 36- SLIDE WOOD
- 37- INVISIBLE WOOD
- 38- INSIDE
- 40- INSIDE DV
- 41- INSIDE DUO
- 42- DIVISION
- 43- INSIDE DUO GLASS
- 44- TELESCOPIC GLASS
- 45- TELESCOPIC TRIPLE GLASS
- 46- WOOD
- 47- HARMÓNIO

ACESSÓRIOS | *ACCESSORIES / ACCESSOIRES*

- 48- Calhas e Abas | *Tracks and Covers / Rails et Bandeaux*
- 50- Kits de acessórios e amortecedores | *Accessories kits and Damper stops / Kits d'accessoires et Frein amortisseurs*
- 52- Acessórios | Abertura simultânea | Guia inferior | Batentes | *Accessories / Simultaneous opening kit / Floor guide / Buffer / Accessoires / Kit d'ouverture simultanée / Guide inférieure / Butté*
- 54- Perfis inferiores | Suportes para porta | Suportes para calhas | *Floor profiles / Door brackets / Track brackets / Profiles inférieurs / Supportes pour porte / Supportes pour rails*

AROS | *FRAMES / HUISSERIES*

- 56- Aros em madeira (Unico) | *Wooden frames / Huisseries en bois*
- 57- Aros em madeira (Paralelo e Inverso) | *Wooden frames / Huisseries en bois*
- 58- Aro em alumínio com guarnição | *Aluminium frame with architrave / Huisserie en aluminium avec chambranle*
- 59- Aro em alumínio DESIGN | *Design aluminium frame / Huisserie en aluminium Design*

INTRODUÇÃO | *INTRODUCTION / INTRODUCTION*

A partir do conceito de economia de espaço interior surgiu, em 2005, a OPENSAPCE, uma marca dedicada ao desenvolvimento, produção e comercialização de soluções e sistemas para portas de correr. Com uma vasta gama de sistemas de embutir e de aplicação à parede, a OPENSAPCE disponibiliza soluções para portas de madeira, vidro ou alumínio e que se adaptam a todos os ambientes e estilos de decoração.

From the concept of interior space saving, in 2005, OPENSAPCE has created, a brand dedicated to the development, production and marketing of sliding doors solutions and systems. With a wide range of embedded and wall mounting systems, OPENSAPCE provides solutions for wooden, glass or aluminium doors suitable, for all kinds of spaces and décor styles.

Du concept d'optimisation de l'espace intérieur a émergé, en 2005, OPENSAPCE, une marque dédiée au développement, la production et la commercialisation des solutions et de systèmes pour portes coulissantes. Avec une large gamme des systèmes à galandage et d'applique, OPENSAPCE offre des solutions pour portes en bois, en verre ou en aluminium qui s'adaptent et tous les types d'espaces et styles de décoration.

MADE IN PORTUGAL

| CAIXILHOS | *POCKET FRAMES / CONTRE-CHÂSSIS* | Pag 6 - 25



| EASY KITS | *EASY KITS* | Pag 26 - 47



| ACESSÓRIOS | *ACCESSORIES / ACCESSOIRES* | Pag 48 - 55



ECONOMIA DE ESPAÇO | SPACE SAVING | GAIN D'ESPACE

A porta de correr tornou-se um elemento essencial em qualquer ambiente, devido à economia de espaço que proporciona e à facilidade na utilização.

Com os caixilhos OPENSACE, a porta desliza suavemente para o interior da parede, ficando totalmente oculta e dotando o seu espaço de elegância e funcionalidade.

Com uma enorme versatilidade, estas soluções podem ser aplicadas em qualquer tipo de divisão, criando espaços amplos e personalizados.

The sliding door has become an essential element in any room, due to the space saving it provides and for its ease of use.

With OPENSACE pocket frames, the door slides smoothly into the wall, remaining completely hidden and endowing your space with elegance and functionality.

With tremendous versatility, these solutions can be applied to any division type, creating customized and ample spaces.

La porte coulissante est devenue un élément essentiel dans toutes les pièces, en raison du gain d'espace qu'il offre et de sa facilité d'utilisation. Avec des caissons OPENSACE, la porte glisse en souplesse dans le mur, restant complètement caché et dotant votre espace avec élégance et fonctionnalité.

Avec une polyvalence extraordinaire, ces solutions peuvent être appliquées à tout type de division, créant des espaces amples et personnalisés.

■ Projeto com portas tradicionais
Project with traditional doors
Projet avec des portes traditionnelles

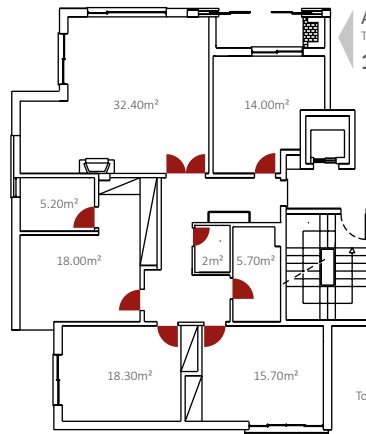

■ Projeto com portas de correr
Project with sliding doors
Projet avec des portes coulissantes

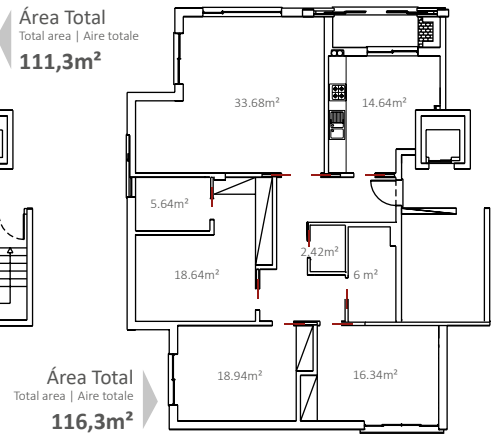

Economia de **5m²** na área útil deste apartamento com portas de correr
Save up to **5m²** in the living space of this apartment with OPENSACE sliding doors
Gain de **5m²** de surface utile de cet appartement avec des portes à galandage OPENSACE

CAIXILHO PARA PORTA DE CORRER

Pocket frame for sliding doors | Contre-châssis pour portes à galandage



Legenda | Legend | Légende

- 1- Calha superior em alumínio | Aluminium top track | Rail supérieur en aluminium
Pré-aro metálico (modelo Unico) outros modelos em madeira | Metallic door post (model Unico) others models in wood
Pré-cadre métallique (modèle Unico) autres modèles en bois
- 2- Distanciador metálico | Metallic spacer | Entretoise métallique
- 3- Marca da cota de nível 1.00 m | 1.00 m level mark | Repère de niveau 1.00 m
- 4- Embalagem de acessórios de montagem do caixilho | Pocket frame assembly accessories set
Sachet des accessoires de montage du caisson
- 5- Base chapa metálica com furação para guia inferior | Drilled metallic base for floor guide installation
Base en tôle percée pour la guide inférieur
- 6- Caixilho com travessas de reforço L ≥ 900 ou H ≥ 2200 | Reinforcing beam frame takes LP ≥ 900 or HP ≥ 2200
Caissons prend poutre de renfort LP ≥ 900 or HP ≥ 2200
- 7- Abertura para controlo dos acessórios de montagem | Opening for control of the assembly accessories set
Ouverture pour vérification de la contenance des accessoires de montage



CARATERÍSTICAS TÉCNICAS DOS CAIXILHOS OPENSAPCE

Frames for sliding doors - technical characteristics | Caractéristiques techniques du contre-châssis pour portes coulissantes

- Caixa de corpo único fabricado em chapa galvanizada de 0,5 a 1 mm de espessura consoante a largura do caixilho (DX51D +Z (F). Certificado EN 10142 com massa de revestimento de zinco nas duas faces de 200g/m². Chapa com canelado vertical com espaçamento de 100/200 mm.

- Componentes da caixa metálica montado com sistema "spot clinch" sem qualquer ponto de soldadura evitando assim pontos de corrosão.

- Calha superior em alumínio anodizado.

- Base e topo do caixilho em chapa galvanizada.

- Pré-aro metálico nos modelos UNICO e UNIKIT e de madeira nos restantes modelos.

- Rodízios com rolamento de agulhas com a capacidade máxima de 80 | 120kg por porta, testados por entidade certificada de acordo com a norma 1527:2013.

- Rede galvanizada para aderência ao reboco (de acordo com cada modelo).

- Rede de fibra de vidro para aplicação entre a alvenaria e o caixilho metálico para evitar a fissuração.

- Distanciadores metálicos.

- Single bodied frame manufactured in galvanized metal sheet with 0,5 to 1 mm thickness according to the width of boxes (DX51D +Z (F). Certificate EN 10142 with 200 gr./m² zinc coating on both sides. Vertical corrugated metal sheet with 100/200 mm spacing.

- Frame components assembled with "spot clinch" system without welding avoiding any corrosion points.

- Anodized aluminium top track.

- Pocket box bottom and top profile in galvanized.

- Metallic strut in UNICO and UNIKIT models, and wooden strut in the other models.

- Needle bearing trolleys for door weights up to 80 | 120 kg by door, tested by a certified entity according to standard 1527: 2013.

- Galvanized mesh for mortar adherence (according to each model).

- Glass fiber mesh to be applied between pocket box and mortar wall structure to avoid cracking.

- Metallic spacers.

Contre-châssis monobloc fabriqué en tôle galvanisée d'une épaisseur de 0,5 à 1 mm selon le largeur du caisson (DX51D +Z (F) Certificat EN 10142. Revêtement des deux faces en zinc de 200 g/m². Tôle cannelée verticalement pour une meilleure rigidité, avec espacements de 100/200 mm selon les dimensions.

Assemblage du caisson à travers le système « spot clinch », sans aucun point de soudure, évitant ainsi les points de corrosion.

- Rail supérieur en aluminium anodisé.

- Base inférieure du contre-châssis en tôle galvanisé.

- Pré-cadre métallique pour le modèle UNICO et UNIKIT et pré-cadre en bois pour les modèles restants.

- Chariots de coulissement avec roulements à aiguilles, pour une capacité de charge maximum de 80 | 120 kg par porte testé par une entité certifiée selon la norme 1527: 2013.

- Grillage galvanisé pour fixation de l'enduit (selon chaque modèle).

- Fibre de verre à appliquer entre l'enduit et le contre-châssis métallique pour éviter la fissuration.

- Entretoises métalliques.

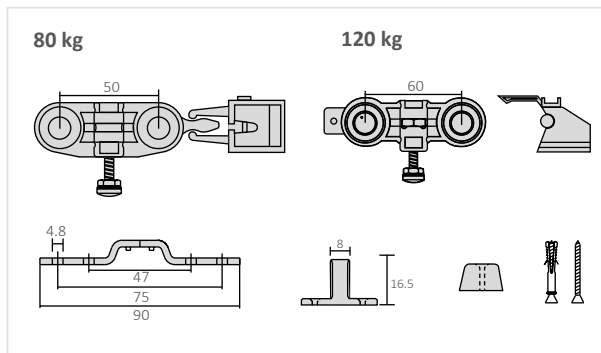

LEI DA ACESSIBILIDADE

Accessibility regulations | Loi d'accessibilité

A GOSIMAT alerta para ter especial atenção ao Decreto-Lei 163/2006 de 8 de Agosto (Lei das acessibilidades).

-Este decreto-lei abrange todo o tipo de habitações, sejam elas moradias unifamiliares ou plurifamiliares.

- A largura útil das portas deverá não ser inferior a 770 mm e a altura útil não inferior 2000 mm.

- Em relação às portas de correr, a GOSIMAT aconselha os clientes a aplicar por exemplo um caixilho OPENSAPCE modelo UNICO com a largura de 900 mm, permitindo ter uma porta de 1000 mm de largura de modo a colocar um puxador, ficando com uma largura útil de passagem não inferior a 775 mm.

Customers outside Portugal should check the accessibility regulations for their country.

Les clients résidant hors Portugal doivent consulter la Loi d'accessibilité de leur pays.

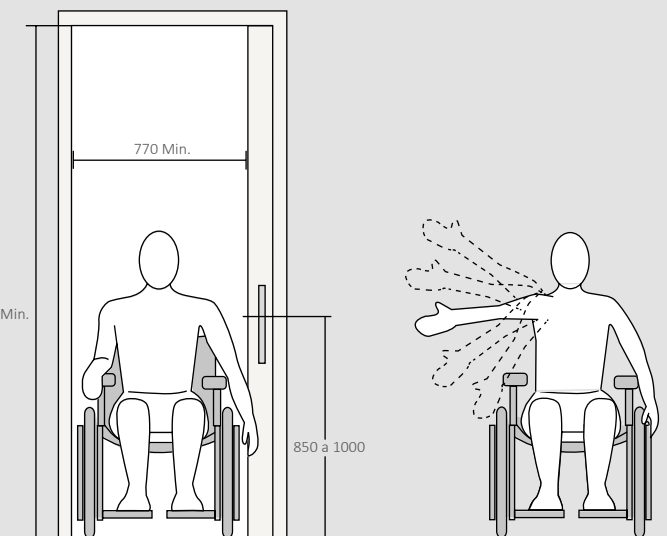
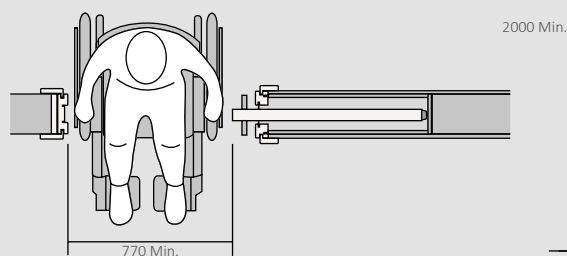

GARANTIA OPENSAPCE

Openspace Warranty | Garantie Openspace

- A **Gosimat Lda.** garante, por um período de 10 (dez) anos, a anti corrosão dos produtos "**OPENSAPCE**" que são fabricados com chapa de aço galvanizada (DX51D + Z200) certificado EN10142, calhas de alumínio (NP EN 12020 NP EN 755) e rede galvanizada para aderência do reboco.

- A Gosimat Lda. garante, por um período de 10 (dez) anos, o bom funcionamento de todos os acessórios e rodízios com 4 rolamentos de esferas com a capacidade de 80 e 120 Kg uso doméstico. Os rodízios foram testados por uma entidade certificada de acordo com a NORMA 1527:2013. Para ambientes comerciais, e tratando-se de componentes de desgaste, a garantia dos rodízios é de 5 (cinco) anos.

- O amortecedor EASY SOFT é considerado também um artigo de grande desgaste, mais propriamente devido ao seu mecanismo a ar, nesse sentido o seu período de garantia é de 2 (dois) anos.

- As instruções de montagem que se encontram dentro de cada uma das embalagens, devem ser tecnicamente respeitadas.

- **Gosimat Lda** provides a 10 years guarantee on the anti-corrosion of the following "**OPENSAPCE**" Pocket Door Frames components: frame's body manufactured in galvanized steel sheet (DX51D + Z200) certificate EN10142, frame's bottom profile, aluminium tracks (NP EN 12020 NP EN 755) and the galvanized mesh for plaster adherence.

- Gosimat Lda. provides a 10 years guarantee on the well function of all accessories and needle bearing trolleys with 80 and 120 kg home use load capacity. The needle bearing trolleys were tested by a certified entity in accordance with the STANDARD 1527: 2013.

- For commercial establishments, and in the case of wear components, the needle bearing trolleys warranty is 5 years. The EASY SOFT shock absorber is also considered a very wear resistant component, more properly due its air mechanism, so its warranty period is 2 years.

- The instructions that are supplied inside the product's package must be technically followed.

- **Gosimat Lda** garantit, pour une période de 10 ans, l'anti-corrosion de les produits "**OPENSAPCE**" qui sont fabriqués avec des tôles d'acier galvanisée (DX51D + Z200) certifiée EN10142, rails en aluminium (NP EN 12020 NP EN 755) et réseau galvanisé pour l'adhérence du plâtre.

- Le Gosimat Lda offre une garantie de 10 ans sur le bon fonctionnement de tous les accessoires et chariots avec roulements à aiguilles avec une capacité de charge de 80 et 120 kg usage domestique. Les chariots avec roulements à aiguilles ont été testés pour une entité certifiée conformément à la NORME 1527: 2013.

- Pour les établissements commerciaux et dans le cas de composants d'usure, la garantie des chariots avec roulements à aiguilles est de 5 ans.

L'amortisseur EASY SOFT est également considéré comme un composant très résistant à l'usure, plus précisément en raison de son mécanisme d'air, sa seule période de garantie étant de 2 ans.

- Les instructions fournies dans l'emballage du produit doivent être suivies techniquement.

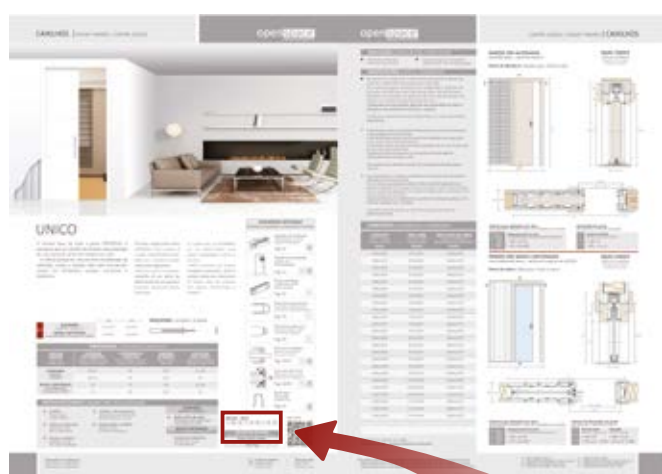

NORMA EN1527 : 2013

Classificação geral

Overall Rating | Note globale

DURABILIDADE

Durability
Durabilité

- 1 2500 Ciclos | Cycles
- 2 5000 Ciclos | Cycles
- 3 10.000 Ciclos | Cycles
- 4 25.000 Ciclos | Cycles
- 5 50.000 Ciclos | Cycles
- 6 100.000 Ciclos | Cycles

SEGURANÇA DE PESSOAS

People security
Sécurité des personnes

- 1 Sistema de acordo com esta norma
System according to this standard
Système conforme à cette norme

TIPO DE SISTEMA

System type
Type de système

- 1 Porta de correr
Sliding door | Porte coulissante
- 2 Porta de harmónio
Folding door | Porte pliante
- 3 Porta de livro multi-painéis
Folding doors | Portes repliables

-	6	2	-	1	0	-	1	3
---	---	---	---	---	---	---	---	---

MASSA DA PORTA

Door mass
Masse de la porte

- 1 ≤ 50 Kg
- 2 51 ≤ X ≤ 100 Kg
- 3 101 ≤ X ≤ 330 Kg
- 4 >330 Kg

RESISTÊNCIA À CORROSÃO

Corrosion resistance
Résistance à la corrosion

- 0 Não testado
not tested
non testé
- 1 24h baixa resistência
24h low resistance
24h basse résistance
- 2 48h resistência moderada
48h moderate resistance
48h résistance modérée
- 3 48h resistência alta
48h high resistance
48h haute résistance

ATRITO INICIAL*

Initial friction
Friction initial

*	≤ 50 Kg	50 ≤ X ≤ 100 Kg	101 ≤ X ≤ 330 Kg	> 330 Kg
1	50 N	80 N	100 N	5% Mass
2	40 N	60 N	5% Mass	50 N
3	30 N	40 N	4% Mass	50 N



PORTA | Door | Porte



MADEIRA
Wood | Bois

LACADO | Lacquered | Laqué
Branco | White | Blanc



ARO | Frame | Huisserie



WPC **LACADO** | Lacquered | Laqué
Branco | White | Blanc



CONCHA | Flush | Vette

INOX
Steel | Acier

Ref.: 16.414 BA
● Black Anthracite

UNICO

O modelo base de toda a gama OPENSACE é composto por um caixilho de embutir para aplicação de uma porta de correr em madeira ou vidro. O UNICO apresenta uma enorme versatilidade de utilização, sendo a solução ideal para economizar espaço em habitações, espaços comerciais e hoteleiros.

The base model of the entire OPENSACE series consists of a single embedded pocket frame for a wooden or glass sliding door application. UNICO presents a tremendous versatility of use, being the ideal solution for saving space in homes, commercial spaces and hotels.

Le modèle base de l'OPENSACE est un contre-châssis pour portes à glanage en bois ou en verre. L'UNICO présente une énorme versatilité d'utilisation, étant la solution idéale pour économiser de l'espace dans des maisons, des espaces commerciaux et hôteliers.

ESPESSURAS | THICKNESS | ÉPAISSEUR

REF:		70	90
	ALVENARIA MORTAR/ENDUIT	10.0105	10.0107
	GESSO CARTONADO PLASTERBOARD/PLAQUES DE PLÂTRE	10.0101	10.0103



ESPESSURAS | THICKNESS | ÉPAISSEUR

TIPO DE PAREDE WALL TYPE TYPE DE MUR	INTERIOR DO CAIXILHO POCKET FRAME INTERIOR INTÉRIEUR DU CAISSON	EXTERIOR DO CAIXILHO POCKET FRAME EXTERIOR EXTÉRIEUR DU CAISSON	PAREDE ACABADA FINISHED WALL MUR FINI	ESPESSURA MÁX. PORTA MAX. DOOR THICKNESS ÉPAISSEUR MAX. PORTE
ALVENARIA MORTAR ENDUIT	52	70	100	40
	72	90	120	55
GESSO CARTONADO PLASTERBOARD PLAQUES DE PLÂTRE	52	70	96 128*△	40
	72	90	116 148*△	55

ARTIGOS INCLuíDOS | INCLUDED ITEMS | ARTICLES INCLUS:

1x Caixilho Pocket frame Contre-châssis	1x 10002 Kit acessórios Pocket frame accessories Kit Kit d'accessoires caissons	ALVENARIA MORTAR ENDUIT
1x Calha em alumínio Aluminium track Rail en aluminium	2x Distanciador metálico Metallic spacer Entretoise métallique	
1x Pré-aro metálico Metallic doorpost Pré-cadre métallique		GESSO CARTONADO PLASTERBOARD PLAQUES DE PLÂTRE
		Parafusos fosfatados 3.5x19 Phosphated screws Vis phosphatées

ACESSÓRIOS OPCIONAIS
OPTIONAL ACCESSORIES | ACCESSOIRES EN OPTION

	Suporte de embutir Embedded door bracket Supporte d'encastrement	Pag: 54
	Travão amortecedor Damper stop Frein amortisseur	Pag: 51
	Pinça contínua Continuous clamp Pince continue	Pag: 52
	Borracha ajustável A Adjustable rubber seal A Joint butée ajustable MOD A	Pag: 55
	Borracha adesiva C Adhesive rubber seal C Joint butée adhésif C	Pag: 55
	Aros em madeira Wooden door frame Huisserie en bois	Pag: 56/57
	Aros em alumínio Aluminium door frame Huisserie en aluminium	Pag: 58/59
	Perfil PVC 7014 PVC profile Profil en PVC	Pag: 54

EN1527 : 2013

- 6 2 - 1 0 - 1 3

CAPACIDADE MÁXIMA
MAXIMUM CAPACITY / CAPACITE MAXIMALE

Porta | Door | Porte

80 Kg

QR CODE



* PT Caixilho gesso cartonado L ≥ 900 or H ≥ 2200 fornecido com travessas de reforço horizontais. Requer a aplicação de 2 placas de gesso BA13 em cada face. Consultar instruções de montagem. EN Pocket frame for Plasterboard L ≥ 900 or H ≥ 2200 supplied with horizontal reinforcement bars. Requires the installation of 2 BA13 plasterboard sheets on each side of the pocket. Check installation guide. FR Caisson pour plaques de plâtre L ≥ 900 or H ≥ 2200 fourni avec barres de renfort horizontales. Il requiert l'application de 2 plaques de plâtre BA13 sur chaque côté du caisson. Consultez notice de pose. PT Tolerância dimensional: 3mm | EN Dimensional tolerance : 3mm | FR Tolérance dimensionnelle: 3 mm

APLICAÇÃO | APPLICATION

- Parede de Alvenaria
Mortar wall | Mur en enduit
- Parede de gesso Cartonado
Plasterboard wall | Mur en plaque de plâtre

OBSERVAÇÕES | NOTES | REMARQUES

- No quadro de espessuras, as dimensões da parede acabada são mínimas e dependem do acabamento efetuado. Na versão para gesso cartonado, foi considerada a aplicação de uma placa de BA13 de cada lado da estrutura. Na versão para alvenaria, recomenda-se a aplicação de uma camada mínima de reboco com 15mm de cada lado da estrutura. A espessura final da parede depende da quantidade de reboco aplicado e do revestimento final (ex.: azulejo).
A espessura máxima da porta já inclui bites ou outros elementos decorativos.

- In the thickness chart, the finished wall dimensions are minimum dimensions and they depend on the finish type. In the plasterboard version, we considered the installation of a single BA13 sheet on each side of the wall structure. In the mortar version, we recommend the application of a 15 mm mortar layer on each side of the wall structure. The final wall thickness depends on the quantity of mortar applied and the final wall covering (ex.: tile)

The maximum door thickness includes the moulding and other decorative elements.

- Les dimensions présentées sont les dimensions minimums possibles. Pour la version pour plaques de plâtre, nous avons considéré l'application d'une plaque BA13 de chaque côté de la structure. Pour la version à enduire, nous avons considéré l'épaisseur minimum d'enduit nécessaire indiqué par les rebords du caisson. L'épaisseur de la cloison finie peut être supérieure à ces dimensions en fonction de la quantité d'enduit appliqué et du revêtement de la cloison (exemple: application de carrelage).

L'épaisseur maximale de la porte comprend le moulage et d'autres éléments décoratifs.

DIMENSÕES | DIMENSIONS

CAIXILHO POCKET FRAME CONTRE-CHÃSSIS (LxH)	VÃO LIVRE CLEAR OPENING PASSAGE LIBRE (PLxHL)	VÃO TOTAL DE OBRA OVERALL DIMENSION DIMENSION D'ENCOMBREMENT (LTxHT) **
600x2000	575x1995	1290x2100
600x2100	575x2095	1290x2200
600x2400	575x2395	1290x2500
700x2000	675x1995	1490x2100
700x2100	675x2095	1490x2200
700x2400	675x2395	1490x2500
750x2000	725x1995	1590x2100
750x2100	725x2095	1590x2200
750x2400	725x2395	1590x2500
800x2000	775x1995	1690x2100
800x2100	775x2095	1690x2200
800x2400	775x2395	1690x2500
900x2000	875x1995	1890x2100
900x2100	875x2095	1890x2200
900x2400	875x2395	1890x2500
1000x2000	975x1995	2090x2100
1000x2100	975x2095	2090x2200
1000x2400	975x2395	2090x2500
1100x2000	1075x1995	2290x2100
1100x2100	1075x2095	2290x2200
1100x2400	1075x2395	2290x2500
1200x2000	1175x1995	2490x2100
1200x2100	1175x2095	2490x2200
1200x2400	1175x2395	2490x2500

Cores de Portas e Aros | Consulte catálogo Nº2 PORTAS
Door and Door frame colours | Check Door catalogue Nº2
Couleurs des portes et Huisseries | Consultez catalogue Nº2 Portes

Possibilidade de fabrico por medida
Custom-size frames also possible | Possibilité de fabrication sur mesure

Dimensões em milímetros | Dimensions in millimeters | Dimensions en millimètres

PAREDE EM ALVENARIA

MORTAR WALL | MUR EN ENDUIT

Porta de Madeira | Wooden door | Porte en bois

Aros em madeira | Wooden door frame | Huisserie en bois

Opção | Option

Com guarnição
With Architrave
Avec chambranles

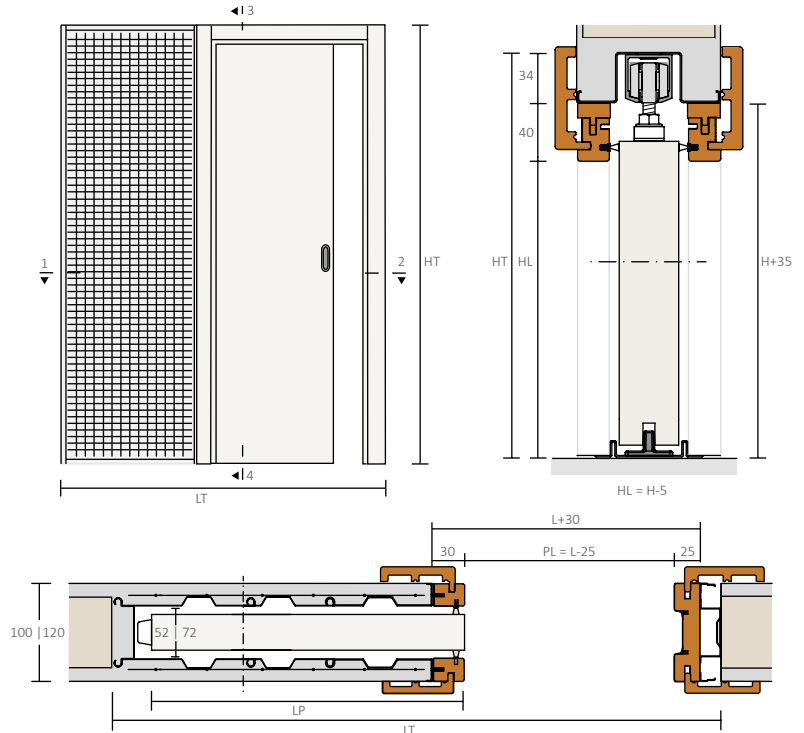

Cálculo para aplicação em obra

On-site application calculator | Calcul pour l'installation sur le chantier

- Dimensão total em obra**
Overall dimensions | Dimension de l'encombrement:
- HT = H+100
 - LT = 2xL+90

Dimensão da porta

Door dimensions | Dimension de la porte

- Porta de madeira**
Wooden door | Porte en bois:
- HP = H
 - LP = L (min)

PAREDE EM GESSO CARTONADO

PLASTERBOARD WALL | MUR EN PLAQUES DE PLÂTRE

Porta de vidro | Glass door | Porte en verre

Aros em alumínio | Aluminium door frame | Huisserie en aluminium

Opção | Option

DESIGN

Sem guarnição
Without Architrave
Sans chambranle

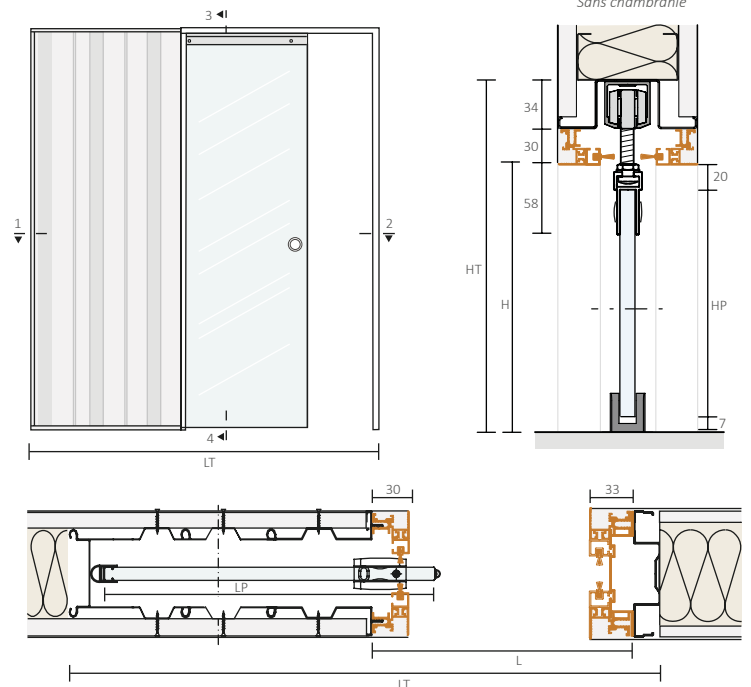

Cálculo para aplicação em obra

On-site application calculator | Calcul pour l'installation sur le chantier

- Dimensão total em obra ****
Overall dimensions | Dimension de l'encombrement:
- HT = H+64
 - LT = 2xL+60

Cálculo da dimensão da porta

Door dimensions | Dimension de la porte

- Porta de vidro**
Glass door | Porte en verre: Easy soft
Easy soft | Easy soft
- HP = H-27
 - LP(min) = L+85
 - HP = H-10
 - LP(min) = L+85

** Quando o caixilho é aplicado em paredes de gesso cartonado, o vão total de obra é H+70 X 2xL+60
When applied in plasterboard walls, the overall dimension is H+70 X 2xL+60
Quand le caisson est installé en mur de plaque de plâtre, la dimension total de l'encombrement est H+70 X 2xL+60

H - Altura | Height | Hauteur
HP - Altura da porta | Door height | Hauteur de la porte
HL - Altura livre | Clear height | Hauteur libre
HT - Altura total | Total height | Hauteur total
L - Largura | Width | Largeur
LP - Largura da porta | Door width | Largeur de la porte
PL - Passagem livre | Clear opening | Passage libre
LT - Largura total | Total width | Largeur total



PORTA | Door | Porte

VIDRO | Glass | Verre

BRONZE | Bronze | Bronze

ARO | Frame | Huisserie

ALUMÍNIO | Aluminium

LACADO | Lacquered | Laqué

Branco | White | Blanc

DESIGN

CONCHA | Flush | Vette

INOX | Steel | Acier

Ref.: 2844 (141)

● Titânio | Titan

UNICO XL

Desenvolvido para projetos mais exigentes, o UNICO XL é um caixilho de embutir para uma porta de correr de grandes dimensões. Com todas as vantagens de um sistema de correr embutido, o UNICO XL apresenta uma estrutura mais robusta para garantir toda a sua funcionalidade e a qualidade dos sistemas OPENSACE.

Opcional | Optional | Option
EASY SOFT INSIDE

Designed for the most demanding projects, UNICO XL is an embedded pocket frame for the installation of a large sliding door. With all the advantages of an in-wall sliding system, the UNICO XL provides a more robust structure to assure the functionality and quality of OPENSACE systems.

Porta de vidro não comercializada
Glass door not available for sale
Porte en verre indisponible

Conçu pour les projets les plus exigeants, le UNICO XL est un caisson à galandage pour l'installation d'une porte coulissante des grandes dimensions. Avec tous les avantages d'un système coulissant encastré, l'UNICO XL dispose d'une structure plus robuste pour assurer toute la fonctionnalité et la qualité des systèmes OPENSACE.

REF:		ESPESSURAS THICKNESS ÉPAISSEUR	
		70	90
	ALVENARIA MORTAR / ENDUIT	10.0205	10.0207
	GESSO CARTONADO PLASTERBOARD / PLAQUES DE PLÂTRE	10.0201	10.0203

ESPESSURAS THICKNESS ÉPAISSEUR				
TIPO DE PAREDE WALL TYPE TYPE DE MUR	INTERIOR DO CAIXILHO POCKET FRAME INTERIOR INTÉRIEUR DU CAISSON	EXTERIOR DO CAIXILHO POCKET FRAME EXTERIOR EXTÉRIEUR DU CAISSON	PAREDE ACABADA FINISHED WALL MUR FINI	ESPESSURA MÁX. PORTA MAX. DOOR THICKNESS ÉPAISSEUR MAX. PORTE
ALVENARIA MORTAR ENDUIT	52	70	120	40
	72	90	140	55
GESSO CARTONADO PLASTERBOARD PLAQUES DE PLÂTRE	52	70	122 128 *△	40
	57	75	133 *△	40
	72	90	148 *△	55
	82	100	158 *△	55

ARTIGOS INCLUÍDOS INCLUDED ITEMS ARTICLES INCLUS:		
1x Caixilho Pocket frame Contre-châssis	1x 10003 Kit acessórios Pocket frame accessories Kit Kit d'accessoires caissons	ALVENARIA MORTAR ENDUIT
1x Pré-aro madeira Wood doorpost Pré-cadre bois	2x Distanciador metálico Metallic spacer Entretoise métallique	4x Redes fibra de vidro Glass fiber mesh Filet de fibre de verre
1x Calha em alumínio Aluminium track Rail en aluminium		GESSO CARTONADO PLASTERBOARD PLAQUES DE PLÂTRE
		Parafusos fosfatados 3.5x19 Phosphated screws Vis phosphatées

ACESSÓRIOS OPCIONAIS OPTIONAL ACCESSORIES | ACCESSOIRES EN OPTION

Suporte de embutir
Embedded door bracket
Supporte d'encastrement
Pag: 54

Travão amortecedor
Damper stop
Frein amortisseur
Pag: 51

Pinça contínua
Continuous clamp
Pince continue
Pag: 52

Borracha ajustável A
Adjustable rubber seal A
Joint butée ajustable MOD A
Pag: 55

Borracha adesiva C
Adhesive rubber seal C
Joint butée adhésif C
Pag: 55

Aros em madeira
Wooden door frame
Huisserie en bois
Pag: 56/57

Aros em alumínio
Aluminium door frame
Huisserie en aluminium
Pag: 58/59

Perfil PVC 7014
PVC profile
Profil en PVC
Pag: 54

EN1527 : 2013
- 6 3 - 1 0 - 1 3

CAPACIDADE MÁXIMA
MAXIMUM CAPACITY / CAPACITÉ MAXIMALE
Porta | Door | Porte
120 Kg



* PT Caixilho gesso cartonado L ≥ 900 ou H ≥ 2200 fornecido com travessas de reforço horizontais. Requer a aplicação de 2 placas de gesso BA13 em cada face. Consultar instruções de montagem.
EN Pocket frame for Plasterboard L ≥ 900 or H ≥ 2200 supplied with horizontal reinforcement bars. Requires the installation of 2 BA13 plasterboard sheets on each side of the pocket. Check installation guide.
FR Caisson pour plaques de plâtre L ≥ 900 or H ≥ 2200 fourni avec barres de renfort horizontales. Il requiert l'application de 2 plaques de plâtre BA13 sur chaque côté du caisson. Consultez notice de pose.
PT Tolerância dimensional: 3mm | EN Dimensional tolerance : 3mm | FR Tolérance dimensionnelle: 3 mm

APLICAÇÃO | APPLICATION

- Parede de Alvenaria
Mortar wall | Mur en enduit
- Parede de gesso Cartonado
Plasterboard wall | Mur en plaque de plâtre

OBSERVAÇÕES | NOTES | REMARQUES

■ No quadro de espessuras, as dimensões da parede acabada são mínimas e dependem do acabamento efetuado. Na versão para gesso cartonado, foi considerada a aplicação de duas placas de BA13 de cada lado da estrutura. Na versão para alvenaria, recomenda-se a aplicação de uma camada mínima de reboco com 25mm de cada lado da estrutura. A espessura final da parede depende da quantidade de reboco aplicado e do revestimento final (ex.: azulejo).

A espessura máxima da porta já inclui bites ou outros elementos decorativos.

■ In the thickness chart, the finished wall dimensions are minimum dimensions and they depend on the finish type. In the plasterboard version, we considered the installation of two BA13 sheet on each side of the wall structure. In the mortar version, we recommend the application of a 25 mm mortar layer on each side of the wall structure. The final wall thickness depends on the quantity of mortar applied and the final wall covering (ex.: tile)

The maximum door thickness includes the moulding and other decorative elements.

■ Pour des épaisseurs ci-dessous, les dimensions du mur fini sont minimales et dépendant de la finition réalisée. Pour la version pour plaques de plâtre, il était considéré l'application de deux plaques de plâtre BA13 de chaque côté de la structure. Pour la version d'enduit, il est recommandé d'appliquer une couche de plâtrage avec un minimum de 25 mm de chaque côté du caisson. L'épaisseur finale du mur dépend de la quantité de la plâtrage appliquée et de la finition appliquée (ex.: carrelage).

L'épaisseur maximale de la porte comprend le moulage et d'autres éléments décoratifs.

DIMENSÕES | DIMENSIONS

CAIXILHO POCKET FRAME CONTRE-CHÂSSIS (LxH)	VÃO LIVRE CLEAR OPENING PASSAGE LIBRE (PLxHL)	VÃO TOTAL DE OBRA OVERALL DIMENSION DIMENSION D'ENCOMBREMENT (LTxHT) **
1400x2000 /2100	1375x1995 /2095	2895x2100/2200
1400x2200 /2300	1375x2195 /2295	2895x2300/2400
1400x2400 /2500	1375x2395 /2495	2895x2500/2600
1500x2000 /2100	1475x1995 /2095	3095x2100 /2200
1500x2200 /2300	1475x2195 /2295	3095x2300 /2400
1500x2400 /2500	1475x2395 /2500	3095x2500 /2600
1600x2000 /2100	1575x1995 /2095	3295x2100 /2200
1600x2200 /2300	1575x2195 /2295	3295x2300 /2400
1600x2400 /2500	1575x2395 /2500	3295x2500 /2600
1700x2000 /2100	1675x1995 /2095	3495x2100 /2200
1700x2200 /2300	1675x2195 /2295	3495x2300 /2400
1700x2400 /2500	1675x2395 /2500	3495x2500 /2600
1800x2000 /2100	1775x1995 /2095	3695x2100 /2200
1800x2200 /2300	1775x2195 /2295	3695x2300 /2400
1800x2400 /2500	1775x2395 /2500	3695x2500/2600
1900x2000 /2100	1875x1995 /2095	3895x2100 /2200
1900x2200 /2300	1875x2195 /2295	3895x2300 /2400
1900x2400 /2500	1875x2395 /2500	3895x2500 /2600
2000x2000 /2100	1975x1995 /2095	4095x2100 /2200
2000x2200 /2300	1975x2195 /2295	4095x2300 /2400
2000x2400 /2500	1975x2395 /2500	4095x2500 /2600

Dimensão máxima

Maximum dimension | Dimension maximale
2000x3000 mm

Cores de Portas e Aros | Consulte catálogo Nº2 PORTAS
Door and Door frame colours | Check Door catalogue Nº2
Couleurs des portes et Huisseries | Consultez catalogue Nº2 Portes



Possibilidade de fabrico por medida

Custom-size frames also possible | Possibilité de fabrication sur mesure

Dimensões em milímetros | Dimensions in millimeters | Dimensions en millimètres

PAREDE EM ALVENARIA

MORTAR WALL | MUR EN ENDUIT

Porta de Madeira | Wooden door | Porte en bois

Aros em madeira | Wooden door frame | Huisserie en bois

Opção | Option

Com guarnição
With Architrave
Avec chambranles

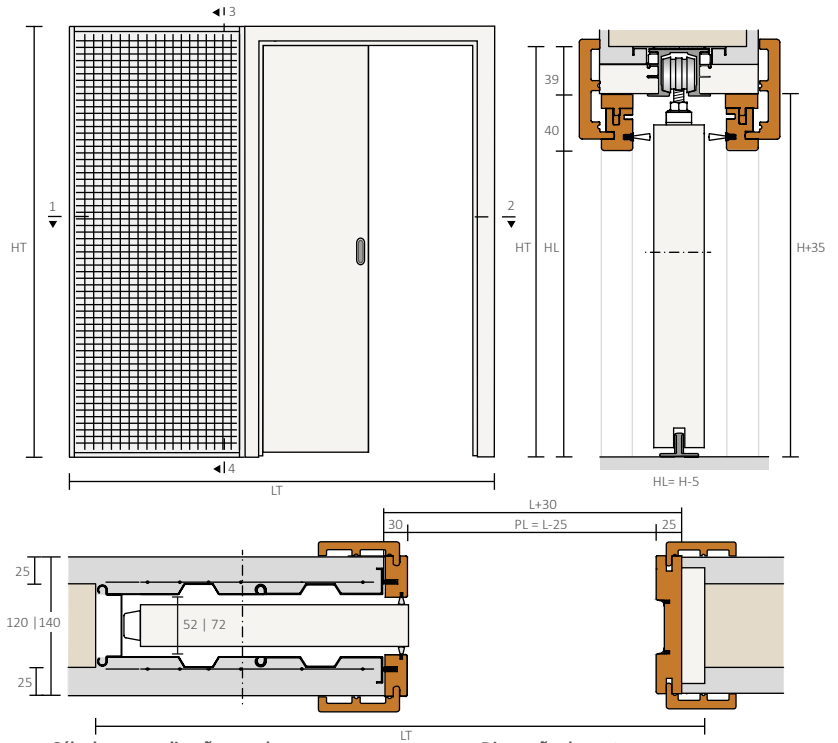

Cálculo para aplicação em obra

Onsite application calculator | Calcul pour l'installation sur le chantier

- Dimensão total em obra**
Overall dimensions | Dimension de l'encombrement:
- HT= H+100
 - LT= 2xL+95

Dimensão da porta

Door dimensions | Dimension de la porte

- Porta de madeira**
Wooden door | Porte en bois:
- HP= H
 - LP= L (min)

PAREDE EM GESSO CARTONADO

PLASTERBOARD WALL | MUR EN PLAQUES DE PLÂTRE

Porta de vidro | Glass door | Porte en verre

Aros em alumínio | Aluminium door frame | Huisserie en aluminium

Opção | Option

DESIGN

Sem guarnição
Without Architrave
Sans chambranle

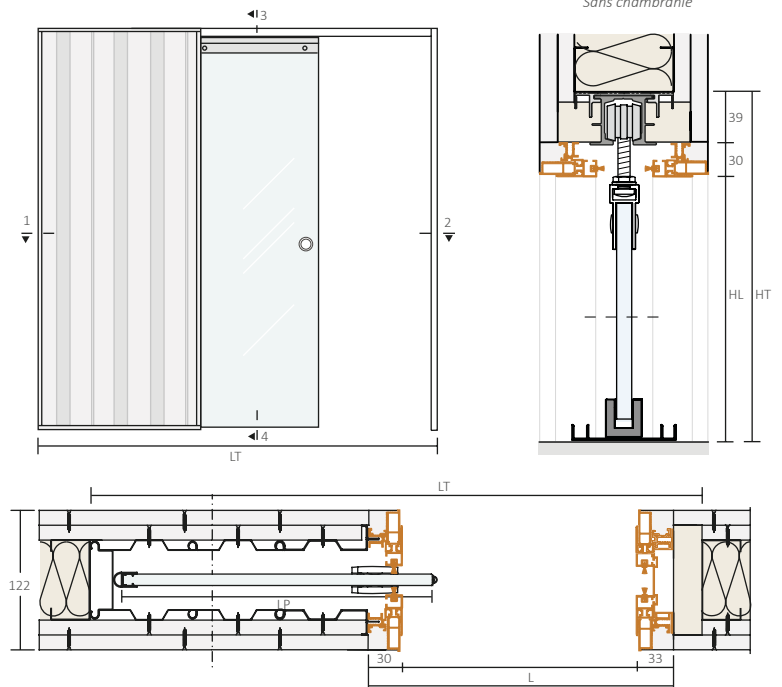

Cálculo para aplicação em obra

On-site application calculator | Calcul pour l'installation sur le chantier

- Dimensão total em obra** **
Overall dimensions | Dimension de l'encombrement:
- HT= H+70
 - LT= 2xL+65

Cálculo da dimensão da porta

Door dimensions | Dimension de la porte

- Porta de vidro**
Glass door | Porte en verre: Easy soft | Easy soft
- HP= H
 - LP(min)= L+85
 - LP(min)= L+85

** Quando o caixilho é aplicado em paredes de gesso cartonado, o vão total de obra é H+70 x 2xL+65
When applied in plasterboard walls, the overall dimension is H+70 x 2xL+65
Quand le caisson est installé en mur de plaque de plâtre, la dimension total de l'encombrement est H+70 x 2xL+65

H - Altura | Height | Hauteur
HP - Altura da porta | Door height | Hauteur de la porte
HL - Altura livre | Clear height | Hauteur libre
HT - Altura total | Total height | Hauteur total
L - Largura | Width | Largeur
LP - Largura da porta | Door width | Largeur de la porte
PL - Passagem livre | Clear opening | Passage libre
LT - Largura total | Total width | Largeur total



PORTA | Door | Porte

PARIS

MADEIRA
Wood | Bois

LACADO | Lacquered | Laqué
Branco | White | Blanc



ARO | Frame | Huisserie

DESIGN

ALUMÍNIO
Aluminium

LACADO | Lacquered | Laqué
Branco | White | Blanc



CONCHA | Flush | Vette

INOX | Steel | Acier
Ref.:2639 (141)
Titanio | Titan

UNICO PLUS

O ÚNICO PLUS é uma solução exclusiva para a aplicação de uma porta de correr de grande dimensão, cuja calha se encontra embutida no teto falso. Com portas até ao teto, o ÚNICO PLUS permite harmonizar as linhas arquitetónicas e conferir maior sensação de espaço, modernidade e sofisticação a qualquer ambiente.

Created for exclusive environments, the UNICO PLUS was designed for the application of a large dimension sliding door applied in the false ceiling and that retracts to a pocket frame embedded in the side wall. With ceiling height doors, this system harmonizes architectural lines, providing greater sense of space, modernity and sophistication to any room.

Opcional | Optional | Option
EASYSOFT INSIDE

Conçu pour les environnements exclusifs, l'UNICO PLUS a été conçu pour l'application d'une porte coulissante de grande dimension qui recueille à l'intérieur du mur et qui coulisse sur un rail encastré dans au faux plafond. Avec des portes jusqu'au plafond, ce système harmonise lignes architecturales, offrant une plus grande sensation d'espace, modernité et de sophistication à toute pièce.

REF:		ESPESSURAS THICKNESS ÉPAISSEUR	
		70	90
	ALVENARIA MORTAR / ENDUIT	10.0305	10.0307
	GESSO CARTONADO PLASTERBOARD / PLAQUES DE PLÂTRE	10.0309	10.0311

ESPESSURAS THICKNESS ÉPAISSEUR				
TIPO DE PAREDE WALL TYPE TYPE DE MUR	INTERIOR DO CAIXILHO POCKET FRAME INTERIOR INTÉRIEUR DU CAISSON	EXTERIOR DO CAIXILHO POCKET FRAME EXTERIOR EXTÉRIEUR DU CAISSON	PAREDE ACABADA FINISHED WALL MUR FINI	ESPESSURA MAX. PORTA MAX. DOOR THICKNESS ÉPAISSEUR MAX. PORTE
ALVENARIA MORTAR ENDUIT	52	70	120	40
	72	90	140	45
GESSO CARTONADO PLASTERBOARD PLAQUES DE PLÂTRE	52	70	122 128*	40
	57	75	133 *	40
	72	90	148 *	45
	82	100	158 *	45

ARTIGOS INCLUÍDOS INCLUDED ITEMS ARTICLES INCLUS:		
1x Caixilho Pocket frame Contre-châssis	1x 10004 Kit acessórios Pocket frame accessories Kit Kit d'accessoires caissons	ALVENARIA MORTAR ENDUIT
1x Pré-aro madeira Wood doorpost Pré-cadre bois	2x Distanciador metálico Metallic spacer Entretoise métallique	4x Redes fibra de vidro Glass fiber mesh Filet de fibre de verre
1x Calha em alumínio Aluminium track Rail en aluminium		GESSO CARTONADO PLASTERBOARD PLAQUES DE PLÂTRE
		Parafusos fosfatados 3.5x19 Phosphated screws Vis phosphatées

EN1527 : 2013
- 6 3 - 1 0 - 1 3

CAPACIDADE MÁXIMA
MAXIMUM CAPACITY / CAPACITÉ MAXIMALE
Porta | Door | Porte
120 Kg

QR CODE



ACESSÓRIOS OPCIONAIS OPTIONAL ACCESSORIES | ACCESSOIRES EN OPTION

	Travão amortecedor Damper stop Frein amortisseur Pag: 51
	Pinça contínua Continuous clamp Pince continue Pag: 52
	Borracha ajustável A Adjustable rubber seal A Joint butée ajustable Pag: 55
	Borracha adesiva C Adhesive rubber seal C Joint butée adhésif C Pag: 55
	Aros em madeira Wooden door frame Huisserie en bois Pag: 56/57
	Aros em alumínio Aluminium door frame Huisserie en aluminium Pag: 58/59



* PT Caixilho gesso cartonado L ≥ 900 ou H ≥ 2200 fornecido com travessas de reforço horizontais. Requer a aplicação de 2 placas de gesso BA13 em cada face. Consultar instruções de montagem. EN Pocket frame for Plasterboard L ≥ 900 or H ≥ 2200 supplied with horizontal reinforcement bars. Requires the installation of 2 BA13 plasterboard sheets on each side of the pocket. Check installation guide. FR Caisson pour plaques de plâtre L ≥ 900 ou H ≥ 2200 fourni avec barres de renfort horizontales. Il requiert l'application de 2 plaques de plâtre BA13 sur chaque côté du caisson. Consultez notice de pose. PT Tolerância dimensional: 3mm | EN Dimensional tolerance : 3mm | FR Tolérance dimensionnelle: 3 mm

APLICAÇÃO | APPLICATION

- Parede de Alvenaria
Mortar wall | Mur en enduit
- Parede de gesso Cartonado
Plasterboard wall | Mur en plaque de plâtre

OBSERVAÇÕES | NOTES | REMARQUES

■ No quadro de espessuras, as dimensões da parede acabada são mínimas e dependem do acabamento efetuado. Na versão para gesso cartonado, foi considerada a aplicação de duas placas de BA13 de cada lado da estrutura. Na versão para alvenaria, recomenda-se a aplicação de uma camada mínima de reboco com 25mm de cada lado da estrutura. A espessura final da parede depende da quantidade de reboco aplicado e do revestimento final (ex.: azulejo).

A espessura máxima da porta já inclui bites ou outros elementos decorativos.

■ In the thickness chart, the finished wall dimensions are minimum dimensions and they depend on the finish type. In the plasterboard version, we considered the installation of two BA13 sheet on each side of the wall structure. In the mortar version, we recommend the application of a 25 mm mortar layer on each side of the wall structure. The final wall thickness depends on the quantity of mortar applied and the final wall covering (ex.: tile)

The maximum door thickness includes the moulding and other decorative elements.

■ Pour des épaisseurs ci-dessous, les dimensions du mur fini sont minimales et dépendant de la finition réalisée. Pour la version pour plaques de plâtre, il était considéré l'application de deux plaques de plâtre BA13 de chaque côté de la structure. Pour la version d'enduit, il est recommandé d'appliquer une couche de plâtrage avec un minimum de 25 mm de chaque côté du caisson.

L'épaisseur finale du mur dépend de la quantité de la plâtrage appliquée et de la finition appliquée (ex.: carrelage).

L'épaisseur maximale de la porte comprend le moulage et d'autres éléments décoratifs.

DIMENSÕES | DIMENSIONS

CAIXILHO POCKET FRAME CONTRE-CHÂSSIS (LxH)	VÃO LIVRE CLEAR OPENING PASSAGE LIBRE (PLxHL)	VÃO TOTAL DE OBRA OVERALL DIMENSION DIMENSION D'ENCOMBREMENT (LTxHT) **
600xH	570xH	1290xH+38
700xH	670xH	1490xH+38
750xH	720xH	1590xH+38
800xH	770xH	1690xH+38
900xH	870xH	1890xH+38
1000xH	970xH	2090xH+38
1100xH	1070xH	2290xH+38
1200xH	1170xH	2490xH+38
1400xH	1370xH	2890xH+38

Fabrico por medida
Made by order | Fabrication sur mesure

Dimensão máxima
Maximum dimension | Dimension maximale
2000x3000 mm

Cores de Portas e Aros | Consulte catálogo Nº2 PORTAS
Door and Door frame colours | Check Door catalogue Nº2
Couleurs des portes et Huisseries | Consultez catalogue Nº2 Portes

A altura do caixilho é sempre definida pela altura do teto falso
The pocket door height is always set by the false ceiling height
L'hauteur du caisson c'est toujours définie par l'hauteur du faux plafond

- Viga em madeira para reduzir vibrações no teto falso (não fornecido)
Wooden beam to reduce the false ceiling vibrations (not supplied)
Poutre en bois pour réduire les vibrations du faux plafond (Non fourni)

Possibilidade de fabrico por medida
Custom-size frames also possible | Possibilité de fabrication sur mesure

Dimensões em milímetros | Dimensions in millimeters | Dimensions en millimètres

PAREDE EM ALVENARIA
MORTAR WALL | MUR EN ENDUIT

Porta de Madeira | Wooden door | Porte en bois
Aros em alumínio | Aluminium door frame | Huisserie en aluminium

Opção | Option
DESIGN

Sem guarnição
Without Architrave
Sans chambranle

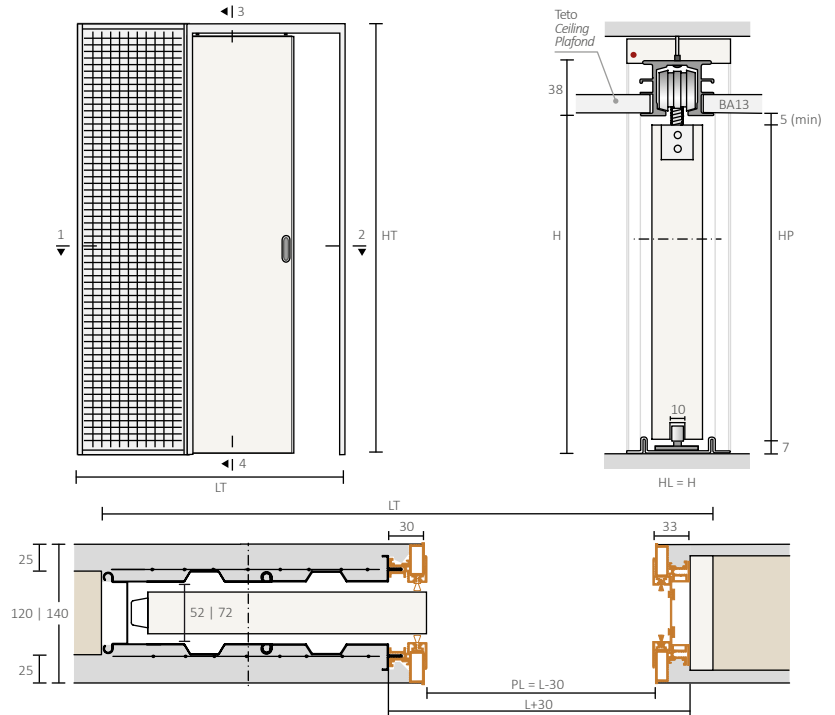

Cálculo para aplicação em obra
Onsite application calculator | Calcul pour l'installation sur le chantier

Dimensão total em obra
Overall dimensions | Dimension de l'encombrement:
■ HT= H+68
■ LT= 2xL+90

Dimensão da porta
Door dimensions | Dimension de la porte

Porta de madeira
Wooden door | Porte en bois:
■ HP = H-12
■ LP = L (min)

PAREDE EM GESSO CARTONADO
PLASTERBOARD WALL | MUR EN PLAQUES DE PLÂTRE

Porta de vidro | Glass door | Porte en verre
Aros em alumínio | Aluminium door frame | Huisserie en aluminium

Opção | Option

Com guarnição
With Architrave
Avec chambranles

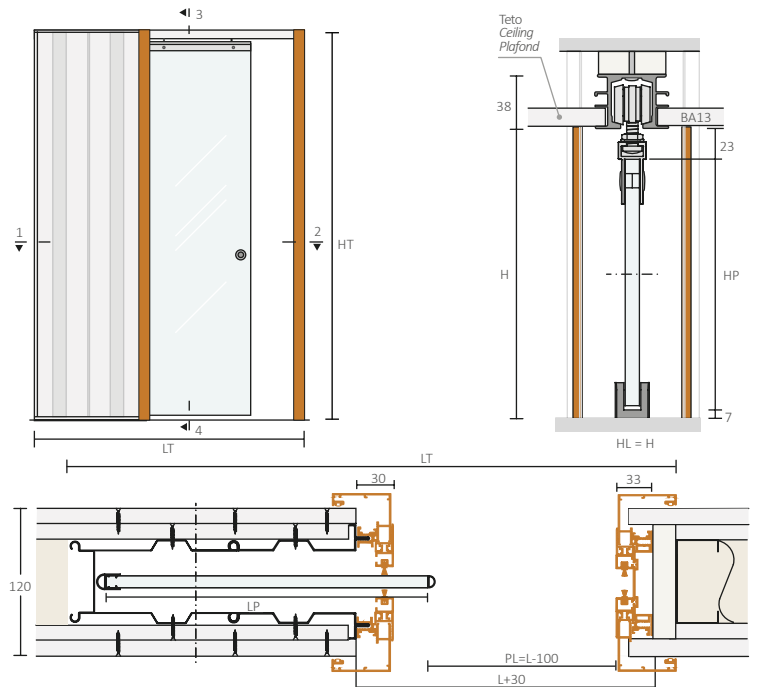

Cálculo para aplicação em obra
On-site application calculator | Calcul pour l'installation sur le chantier

Dimensão total em obra **
Overall dimensions | Dimension de l'encombrement:
■ HT= H+38
■ LT= 2xL+60

Cálculo da dimensão da porta
Door dimensions | Dimension de la porte

Porta de vidro
Glass door | Porte en verre:
■ HP= H-30
■ LP(min)= L+85

** Quando o caixilho é aplicado em paredes de gesso cartonado, o vão total de obra é H+38 X 2xL+60
When applied in plasterboard walls, the overall dimension is H+38 X 2xL+60
Quand le caisson est installé en mur de plaque de plâtre, la dimension total de l'encombrement est H+38 X 2xL+60

H - Altura | Height | Hauteur
HP - Altura da porta | Door height | Hauteur de la porte
HL - Altura livre | Clear height | Hauteur libre
HT - Altura total | Total height | Hauteur total
L - Largura | Width | Largeur
LP - Largura da porta | Door width | Largeur de la porte
PL - Passagem livre | Clear opening | Passage libre
LT - Largura total | Total width | Largeur total



PORTA | Door | Porte

DUBLIN



MADEIRA
Wood | Bois

LACADO | Lacquered | Laqué
Branco | White | Blanc



ARO | Frame | Huisserie

DESIGN



ALUMÍNIO
Aluminium

LACADO | Lacquered | Laqué
Branco | White | Blanc



CONCHA | Flush | Vette



INOX | Steel | Acier



Ref.: 16.414
Black

UNIKIT

O UNIKIT é um sistema de caixilho em kit de fácil manipulação e montagem, desenvolvido especialmente para projetos de renovação e como resposta ao espírito DIY (do it yourself). Inovador e funcional, o UNIKIT permite a instalação de uma porta de correr em madeira ou vidro, podendo ser instalado em todo o tipo de espaços.

The UNIKIT is a pocket frame system in kit form, easy to handle and assemble, specially developed for renovation projects and as a response to the DIY spirit (do it yourself). Innovative and functional, UNIKIT allows the installation of a wooden or glass sliding door and can be installed in all kinds of spaces.

L'UNIKIT c'est un système de caisson en kit de facile manipulation et montage, conçu spécialement pour les projets de rénovation et comme réponse à l'esprit de DIY (do it yourself). Innovant et fonctionnel, l'UNIKIT permet l'utilisation d'une porte coulissante en bois et en verre et peut être installé en tous les types d'espaces.

REF:	GESSO CARTONADO	10.0501
	PLASTERBOARD / PLAQUES DE PLÂTRE	



ESPESSURAS | THICKNESS | ÉPAISSEUR

TIPO DE PAREDE WALL TYPE TYPE DE MUR	INTERIOR DO CAIXILHO POCKET FRAME INTERIOR INTÉRIEUR DU CAISSON	EXTERIOR DO CAIXILHO POCKET FRAME EXTERIOR EXTÉRIEUR DU CAISSON	PAREDE ACABADA FINISHED WALL MUR FINI	ESPESSURA MÁX. PORTA MAX. DOOR THICKNESS ÉPAISSEUR MAX. PORTE
GESSO CARTONADO PLASTERBOARD PLAQUES DE PLÂTRE	52	70	96	40

ARTIGOS INCLUÍDOS | INCLUDED ITEMS | ARTICLES INCLUS:

1x Caixilho Pocket frame Contre-châssis	1x 10002 Kit acessórios Pocket frame accessories Kit Kit d'accessoires caissons	GESSO CARTONADO PLASTERBOARD PLAQUES DE PLÂTRE Parafusos fosfatados 3.5x19 Phosphated screws Vis phosphatées
1x Calha em alumínio Aluminium track Rail en aluminium	2x Distanciador metálico Metallic spacer Entretoise métallique	
1x Pré-aro metálico Metallic doorpost Pré-cadre métallique		

ACESSÓRIOS OPCIONAIS OPTIONAL ACCESSORIES ACCESSOIRES EN OPTION	
	Supporte de embutir Embedded door bracket Supporte d'encasterr Pag: 54
	Travão amortecedor Damper stop Frein amortisseur Pag: 51
	Pinça contínua Continuous clamp Pince continue Pag: 52
	Borracha ajustável A Adjustable rubber seal A Joint butée ajustable Pag: 55
	Borracha adesiva C Adhesive rubber seal C Joint butée adhésif C Pag: 55
	Aros em madeira Wooden door frame Huisserie en bois Pag: 56/57
	Aros em alumínio Aluminium door frame Huisserie en aluminium Pag: 58/59
	Perfil PVC 7014 PVC profile Profil PVC Pag: 54

EN1527 : 2013
- 6 2 - 1 0 - 1 3

CAPACIDADE MÁXIMA
MAXIMUM CAPACITY / CAPACITE MAXIMALE
Porta | Door | Porte
80 Kg



APLICAÇÃO | APPLICATION

- Parede de gesso cartonado
Plasterboard wall | Mur en plaque de plâtre

OBSERVAÇÕES | NOTES | REMARQUES

- No quadro de espessuras, as dimensões da parede acabada são mínimas e dependem do acabamento efetuado. Foi considerada a aplicação de uma placa de BA13 de cada lado da estrutura.

A espessura máxima da porta já inclui bites ou outros elementos decorativos.

- In the thickness chart, the finished wall dimensions are minimum dimensions and they depend on the finish type. we considered the installation of a single BA13 sheet on each side of the wall structure.

The maximum door thickness includes the moulding and other decorative elements.

- Pour des épaisseurs ci-dessous, les dimensions du mur fini sont minimales et dépendant de la finition réalisée. Il était considéré l'application d'une plaque de plâtre BA13 de chaque côté de la structure.

L'épaisseur maximale de la porte comprend le moulage et d'autres éléments décoratifs.

DIMENSÕES | DIMENSIONS

CAIXILHO POCKET FRAME CONTRE-CHÂSSIS (LxH)	VÃO LIVRE CLEAR OPENING PASSAGE LIBRE (PLxHL)	VÃO TOTAL DE OBRA OVERALL DIMENSION DIMENSION D'ENCOMBREMENT (LTxHT)
600X2000	575x1995	1260X2070
600X2100	575x2095	1260X2170
700X2000	675x1995	1460X2070
700X2100	675x2095	1460X2170
750X2000	725x1995	1560X2070
750X2100	725x2095	1560X2170
800X2000	775x1995	1660X2070
800X2100	775x2095	1660X2170
900X2000	875x1995	1860X2070
900X2100	875x2095	1860X2170
1000X2000	975x1995	2060X2070
1000X2100	975x2095	2060X2170
1200x2000	1175x1995	2460X2070
1200x2100	1175x2095	2460X2170

Disponível apenas nas dimensões acima indicadas.
Available only in the dimensions listed above.
Disponible uniquement dans les dimensions ci-dessus.

Cores de Portas e Aros | Consulte catálogo Nº2 PORTAS
Door and Door frame colours | Check Door catalogue Nº2
Couleurs des portes et Huisseries | Consultez catalogue Nº2 Portes

Possibilidade de fabrico por medida
Custom-size frames also possible | Possibilité de fabrication sur mesure

Dimensões em milímetros | Dimensions in millimeters | Dimensions en millimètres

PAREDE EM GESSO CARTONADO
PLASTERBOARD WALL | MUR EN PLAQUES DE PLÂTRE

Porta de Madeira | Wooden door | Porte en bois
Aros em alumínio | Aluminium door frame | Huisserie en aluminium

Opção | Option
DESIGN

Sem guarnição
Without Architrave
Sans chambranle

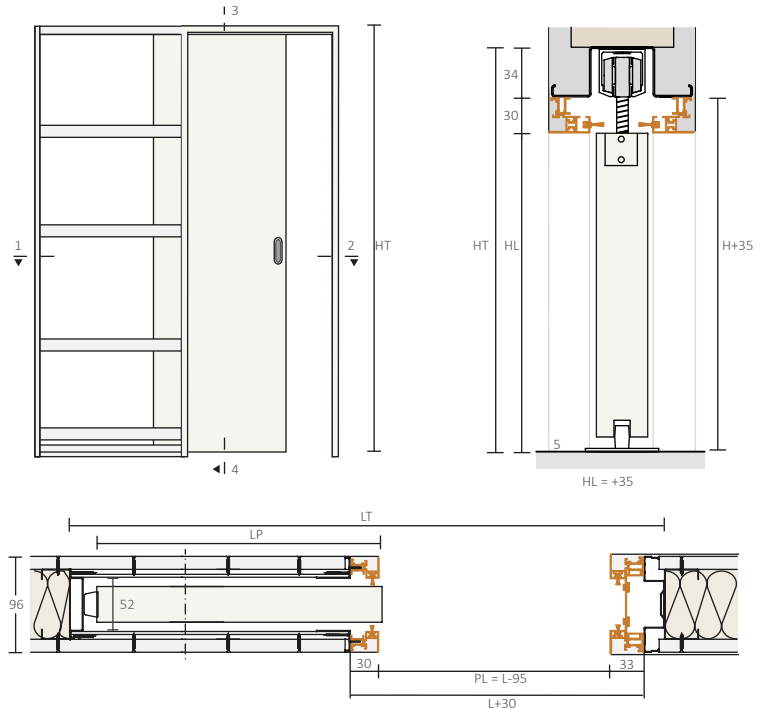

Cálculo para aplicação em obra
On-site application calculator | Calcul pour l'installation sur le chantier

- Dimensão total em obra**
Overall dimensions | Dimension de l'encombrement:
- HT = H + 70
 - LT = 2xL + 60

Dimensão da porta
Door dimensions | Dimension de la porte

- Porta de madeira**
Wooden door | Porte en bois:
- HP = H
 - LP = L (min)

PAREDE EM GESSO CARTONADO
PLASTERBOARD WALL | MUR EN PLAQUES DE PLÂTRE

Porta de vidro | Glass door | Porte en verre
Aros em madeira | Wooden door frame | Huisserie en bois

Opção | Option

Com guarnição
With Architrave
Avec chambranles

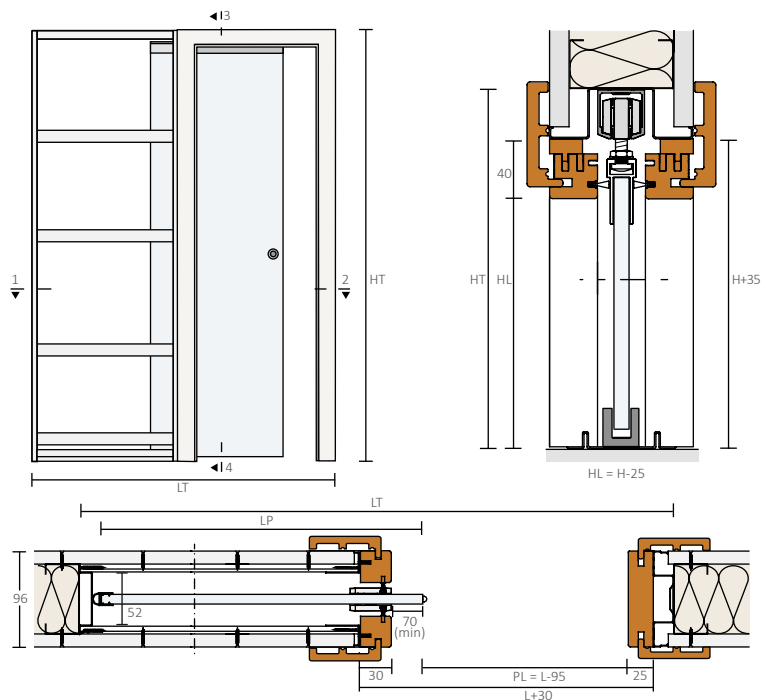

Cálculo para aplicação em obra
On-site application calculator | Calcul pour l'installation sur le chantier

- Dimensão total em obra** **
Overall dimensions | Dimension de l'encombrement:
- HT = H + 70
 - LT = 2xL + 60

Cálculo da dimensão da porta
Door dimensions | Dimension de la porte

- Porta de vidro**
Glass door | Porte en verre:
- HP = H
 - LP(min) = L + 85
- Easy soft**
Easy soft | Easy soft
- HP = H - 10
 - LP(min) = L + 85



PORTA | Door | Porte **DUO** **ARO** | Frame | Huisserie **CONCHA** | Flush | Vette

VIDRO | Glass | Verre **ALUMÍNIO** | Aluminium **LACADO** | Lacquered | Laqué Preto | Black | Noir

Madeira | Wood | Bois **LACADO** | Lacquered | Laqué Preto | Black | Noir

INOX | Steel | Acier Ref.: 2653 **Preto Pérola** | Black Pearl (153)

ENCONTRO

Desenvolvido para ambientes espaçosos, o sistema ENCONTRO permite a aplicação de duas portas de correr opostas embutidas na parede. O sistema ENCONTRO permite separar facilmente salas, escritórios ou ateliers para criar espaços modernos e funcionais.

Designed for spacious rooms, the ENCONTRO system allows the application of two opposite sliding doors built into the wall. The ENCONTRO allows an easy separation of rooms, offices and studios and the creation of modern and highly functional spaces.

Conçu pour les pièces plus spacieuses, le système ENCONTRO permet l'application de deux portes coulissantes opposées. L'ENCONTRO permet la séparation des salons, des bureaux ou des ateliers pour créer des espaces modernes et fonctionnels.

REF:	ALVENARIA MORTAR/ENDUIT	ESPESSURAS THICKNESS ÉPAISSEUR	
		70	90
	10.0605	10.0607	
	GESSO CARTONADO PLASTERBOARD / PLAQUES DE PLÂTRE	10.0601	10.0603

TIPO DE PAREDE WALL TYPE TYPE DE MUR	ESPESSURAS THICKNESS ÉPAISSEUR			
	INTERIOR DO CAIXILHO POCKET FRAME INTERIOR INTÉRIEUR DU CAISSON	EXTERIOR DO CAIXILHO POCKET FRAME EXTERIOR EXTÉRIEUR DU CAISSON	PAREDE ACABADA FINISHED WALL MUR FINI	ESPESSURA MÁX. PORTA MAX. DOOR THICKNESS ÉPAISSEUR MAX. PORTE
ALVENARIA MORTAR ENDUIT	52	70	100	40
	72	90	120	55
GESSO CARTONADO PLASTERBOARD PLAQUES DE PLÂTRE	52	70	96 128 *	40
	72	90	116 148 *	55

ARTIGOS INCLUÍDOS INCLUDED ITEMS ARTICLES INCLUS:	
2x Caixilho Pocket frame Contre-châssis	ALVENARIA MORTAR ENDUIT
1x Calha em alumínio Aluminium track Rail en aluminium	6x Redes fibra de vidro Glass fiber mesh Filet de fibre de verre
2x 10002 Kit acessórios Pocket frame accessories Kit Kit d'accessoires caissons	GESSO CARTONADO PLASTERBOARD PLAQUES DE PLÂTRE
	Parafusos fosfatados 3.5x19 Phosphated screws Vis phosphatées

ACESSÓRIOS OPCIONAIS

OPTIONAL ACCESSORIES | ACCESSOIRES EN OPTION

- Suporte de embutir**
Embedded door bracket
Supporte d'encastrer
Pag: 54
- Travão amortecedor**
Damper stop
Frein amortisseur
Pag: 51
- Pinça contínua**
Continuous clamp
Pince continue
Pag: 52
- Borracha ajustável A e B**
Adjustable rubber seal A and B
Joint butée ajustable A et B
Pag: 55
- Aros em madeira**
Wooden door frame
Huisserie en bois
Pag: 56/57
- Aros em alumínio**
Aluminium door frame
Huisserie en aluminium
Pag: 58/59
- Abertura simultânea**
Syncro kit
Kit Syncro
Pag: 52
- Perfil PVC 7014**
PVC profile
Profil PVC
Pag: 54

EN1527 : 2013
- 6 2 - 1 0 - 1 3

CAPACIDADE MÁXIMA
MAXIMUM CAPACITY / CAPACITÉ MAXIMALE
Porta | Door | Porte
80 Kg



* PT Caixilho gesso cartonado L ≥ 900 ou H ≥ 2200 fornecido com travessas de reforço horizontais. Requer a aplicação de 2 placas de gesso BA13 em cada face. Consultar instruções de montagem. EN Pocket frame for Plasterboard L ≥ 900 or H ≥ 2200 supplied with horizontal reinforcement bars. Requires the installation of 2 BA13 plasterboard sheets on each side of the pocket. Check installation guide. FR Caisson pour plaques de plâtre L ≥ 900 ou H ≥ 2200 fourni avec barres de renfort horizontales. Il requiert l'application de 2 plaques de plâtre BA13 sur chaque côté du caisson. Consultez notice de pose. PT Tolerância dimensional: 3mm | EN Dimensional tolerance : 3mm | FR Tolérance dimensionnelle: 3 mm

APLICAÇÃO | APPLICATION

- Parede de Alvenaria
Mortar wall | Mur en enduit
- Parede de gesso Cartonado
Plasterboard wall | Mur en plaque de plâtre

OBSERVAÇÕES | NOTES | REMARQUES

■ No quadro de espessuras, as dimensões da parede acabada são mínimas e dependem do acabamento efetuado. Na versão para gesso cartonado, foi considerada a aplicação de uma placa de BA13 de cada lado da estrutura. Na versão para alvenaria, recomenda-se a aplicação de uma camada mínima de reboco com 15mm de cada lado da estrutura. A espessura final da parede depende da quantidade de reboco aplicado e do revestimento final (ex.: azulejo).
A espessura máxima da porta já inclui bites ou outros elementos decorativos.

■ In the thickness chart, the finished wall dimensions are minimum dimensions and they depend on the finish type.
In the plasterboard version, we considered the installation of a single BA13 sheet on each side of the wall structure.
In the mortar version, we recommend the application of a 15 mm mortar layer on each side of the wall structure.
The final wall thickness depends on the quantity of mortar applied and the final wall covering (ex.: tile)

The maximum door thickness includes the moulding and other decorative elements.

■ Pour des épaisseurs ci-dessous, les dimensions du mur fini sont minimales et dépendant de la finition réalisée.
Pour la version pour plaques de plâtre, il était considéré l'application d'une plaque de plâtre BA13 de chaque côté de la structure. Pour la version d'enduit, il est recommandé d'appliquer une couche de plâtrage avec un minimum de 15 mm de chaque côté du caisson.
L'épaisseur finale du mur dépend de la quantité de la plâtrage appliquée et de la finition appliquée (ex.: carrelage).

L'épaisseur maximale de la porte comprend le moulage et d'autres éléments décoratifs.

DIMENSÕES | DIMENSIONS

CAIXILHO POCKET FRAME CONTRE-CHÂSSIS (LxH)	VÃO LIVRE CLEAR OPENING PASSAGE LIBRE (PLxHL)	VÃO TOTAL DE OBRA OVERALL DIMENSION DIMENSION D'ENCOMBREMENT (LTxHT) **
1200(600+600)x2000	1165x1995	2480x2100
1200(600+600)x2100	1165x2095	2480x2200
1200(600+600)x2400	1165x2395	2480x2500
1400(700+700)x2000	1365x1995	2880x2100
1400(700+700)x2100	1365x2095	2880x2200
1400(700+700)x2400	1365x2395	2880x2500
1500(750+750)x2000	1465x1995	3080x2100
1500(750+750)x2100	1465x2095	3080x2200
1500(750+750)x2400	1465x2395	3080x2500
1600(800+800)x2000	1565x1995	3280x2100
1600(800+800)x2100	1565x2095	3280x2200
1600(800+800)x2400	1565x2395	3280x2500
1800(900+900)x2000	1765x1995	3680x2100
1800(900+900)x2100	1765x2095	3680x2200
1800(900+900)x2400	1765x2395	3680x2500
2000(1000+1000)x2000	1965x1995	4080x2100
2000(1000+1000)x2100	1965x2095	4080x2200
2000(1000+1000)x2400	1965x2395	4080x2500
2200(1100+1100)x2000	2165x1995	4480x2100
2200(1100+1100)x2100	2165x2095	4480x2200
2200(1100+1100)x2400	2165x2395	4480x2500
2400(1200+1200)x2000	2365x1995	4880x2100
2400(1200+1200)x2100	2365x2095	4880x2200
2400(1200+1200)x2400	2365x2395	4880x2500

Cores de Portas e Aros | Consulte catálogo Nº2 PORTAS
Door and Door frame colours | Check Door catalogue Nº2
Couleurs des portes et Huisseries | Consultez catalogue Nº2 Portes

Possibilidade de fabrico por medida
Custom-size frames also possible | Possibilité de fabrication sur mesure

Dimensões em milímetros | Dimensions in millimeters | Dimensions en millimètres

PAREDE EM ALVENARIA

MORTAR WALL | MUR EN ENDUIT

Opção | Option

Porta de Madeira | Wooden door | Porte en bois

Aros em madeira | Wooden door frame | Huisserie en bois

Com guarnição
With Architrave
Avec chambranles

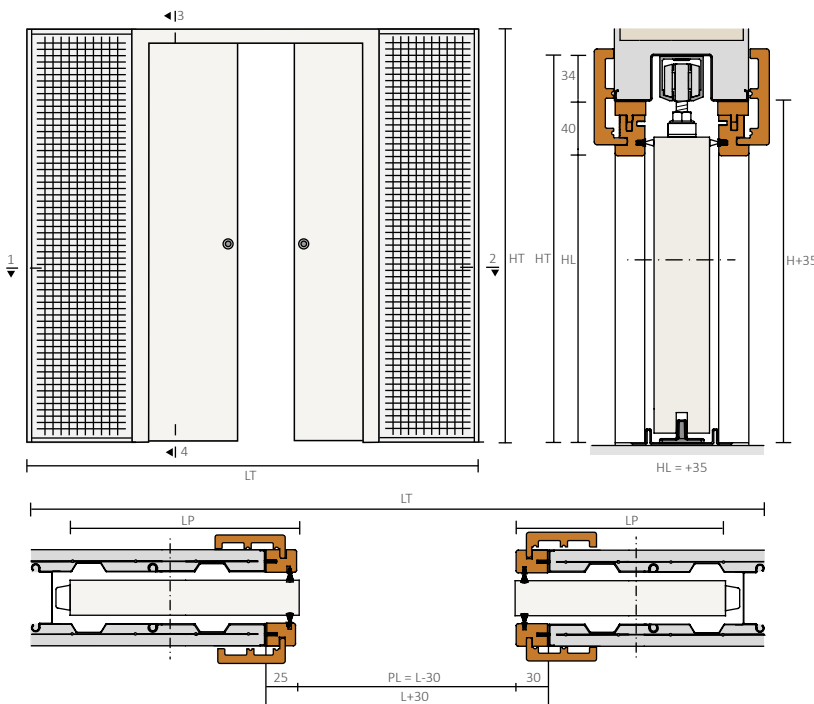

Cálculo para aplicação em obra
On-site application calculator | Calcul pour l'installation sur le chantier

Dimensão total em obra
Overall dimensions | Dimension de l'encombrement:
■ HT = H+100
■ LT = 4xLP+80

Dimensão da porta
Door dimensions | Dimension de la porte

Porta de madeira
Wooden door | Porte en bois:
■ HP = H
■ LP = L/2 (min)

PAREDE EM GESSO CARTONADO

PLASTERBOARD WALL | MUR EN PLAQUES DE PLÂTRE

Opção | Option

Porta de vidro | Glass door | Porte en verre

Aros em alumínio | Aluminium door frame | Huisserie en aluminium

Com guarnição
With Architrave
Avec chambranles

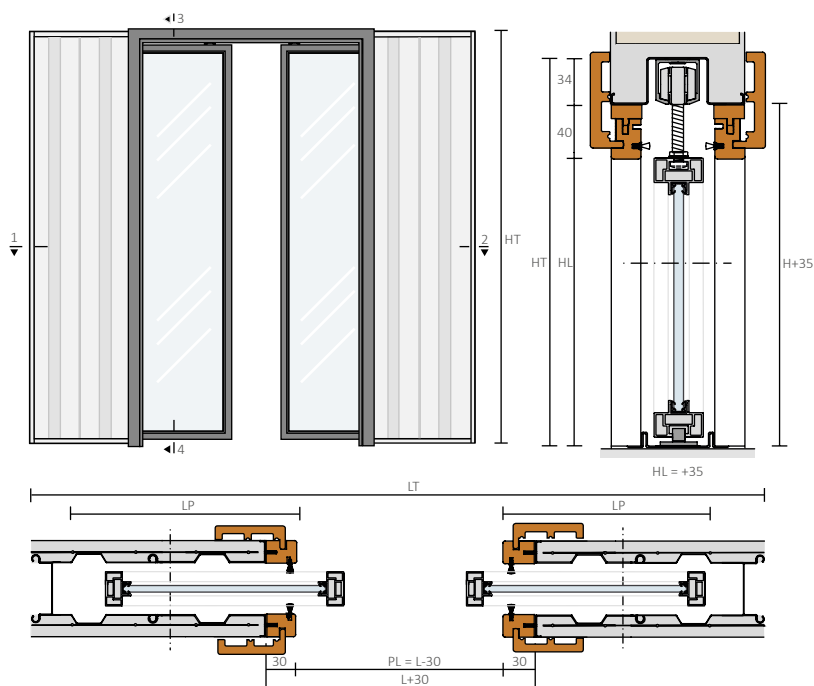

Cálculo para aplicação em obra
On-site application calculator | Calcul pour l'installation sur le chantier

Dimensão total em obra **
Overall dimensions | Dimension de l'encombrement:
■ HT = H+70
■ LT = 4xLP+50

Cálculo da dimensão da porta
Door dimensions | Dimension de la porte

Porta de vidro
Glass door | Porte en verre:
■ HP = H
■ LP = L/2 + 85

Easy soft
Easy soft | Easy soft
■ HP = H-10
■ LP = L/2 + 85

** Quando o caixilho é aplicado em paredes de gesso cartonado, o vão total de obra é H+70 X 4xLP+50
When applied in plasterboard walls, the overall dimension is H+70 X 4xLP+50
Quand le caisson est installé en mur de plaque de plâtre, la dimension total de l'encombrement est H+70 X 4xLP+50

H - Altura | Height | Hauteur
HP - Altura da porta | Door height | Hauteur de la porte
HL - Altura livre | Clear height | Hauteur libre
HT - Altura total | Total height | Hauteur total
L - Largura | Width | Largeur
LP - Largura da porta | Door width | Largeur de la porte
PL - Passagem livre | Clear opening | Passage libre
LT - Largura total | Total width | Largeur total



PORTA | Door | Porte **BARCELONA**

Madeira LACADO | Lacquered | Laqué
Wood | Bois Bege | Beige | NCS S2005-Y50R



ARO | Frame | Huisserie

Madeira Harvest Oak
Wood | Bois Harvest Oak



CONCHA | Flush | Vette

INOX Ref: 4128 (16)
Steel | Acier Satinado | Satin | Satiné

PARALELO WOOD

Pensado para os projetos mais exigentes, o PARALELO WOOD permite a aplicação de duas portas de correr sobrepostas em madeira que recolhem para um único caixilho lateral. Com este sistema, é possível criar vãos de maior amplitude, incorporando uma solução diferenciadora, estética e funcional.

Designed for most demanding customers, the PARALELO WOOD allows the application of two overlapping sliding doors that retracts into a single side pocket frame, creating a greater clear opening width and incorporating an aesthetic and functional solution.

Conçu pour des projets plus exigeants, le PARALELO WOOD permet l'application de deux portes parallèles chevauchantes en bois, qui sont recueillies par un seul caisson latéral. Avec ce système, il est possible de créer un passage libre plus large, intégrant ainsi une solution différenciée, esthétique et fonctionnelle.

ACESSÓRIOS OPCIONAIS	
OPTIONAL ACCESSORIES ACCESSOIRES EN OPTION	
	Travão amortecedor Damper stop Frein amortisseur Pag: 51
	Aros em madeira Wooden door frame Huisserie en bois Pag: 56/57
	Abertura simultânea Syncro kit Kit Syncro Pag: 52
	Perfil PVC 7014 PVC profile Profil PVC Pag: 54

REF:	ALVENARIA MORTAR / ENDUIT	10.1003
	GESSO CARTONADO PLASTERBOARD / PLAQUES DE PLÂTRE	10.1001



ESPESSURAS | THICKNESS | ÉPAISSEUR

TIPO DE PAREDE WALL TYPE TYPE DE MUR	INTERIOR DO CAIXILHO POCKET FRAME INTERIOR INTÉRIEUR DU CAISSON	EXTERIOR DO CAIXILHO POCKET FRAME EXTERIOR EXTÉRIEUR DU CAISSON	PAREDE ACABADA FINISHED WALL MUR FINI	ESPESSURA MAX. PORTA MAX. DOOR THICKNESS ÉPAISSEUR MAX. PORTE
ALVENARIA MORTAR ENDUIT	112	130	160	40
GESSO CARTONADO PLASTERBOARD PLAQUES DE PLÂTRE	112	130	156 188 *△	40

ARTIGOS INCLuíDOS | INCLUDED ITEMS | ARTICLES INCLUS:

1x Caixilho Pocket frame Contre-châssis	2x 10002 Kit acessórios Pocket frame accessories Kit Kit d'accessoires caissons	ALVENARIA MORTAR ENDUIT 8x Redes fibra de vidro Glass fiber mesh Filet de fibre de verre
1x Calha em alumínio Aluminium track Rail en aluminium	1x 7008 Kit Paralelo Wood Paralelo Wood Kit Kit Paralelo Wood	
1x Pré-aro madeira Wood doorpost Pré-cadre bois	2x Distanciador metálico Metallic spacer Entretoise métallique	GESSO CARTONADO PLASTERBOARD PLAQUES DE PLÂTRE Parafusos fosfatados 3.5x19 Phosphated screws Vis phosphatées

EN1527 : 2013
- 6 2 - 1 0 - 1 3

CAPACIDADE MÁXIMA
MAXIMUM CAPACITY / CAPACITÉ MAXIMALE
Porta | Door | Porte
80 Kg



* PT Caixilho gesso cartonado L ≥ 900 ou H ≥ 2200 fornecido com travessas de reforço horizontais. Requer a aplicação de 2 placas de gesso BA13 em cada face. Consultar instruções de montagem. EN Pocket frame for Plasterboard L ≥ 900 or H ≥ 2200 supplied with horizontal reinforcement bars. Requires the installation of 2 BA13 plasterboard sheets on each side of the pocket. Check installation guide. FR Caisson pour plaques de plâtre L ≥ 900 ou H ≥ 2200 fourni avec barres de renfort horizontales. Il requiert l'application de 2 plaques de plâtre BA13 sur chaque côté du caisson. Consultez notice de pose. PT Tolerância dimensional: 3mm | EN Dimensional tolerance : 3mm | FR Tolérance dimensionnelle: 3 mm

APLICAÇÃO | APPLICATION

- Parede de Alvenaria
Mortar wall | Mur en enduit
- Parede de gesso Cartonado
Plasterboard wall | Mur en plaque de plâtre

OBSERVAÇÕES | NOTES | REMARQUES

- No quadro de espessuras, as dimensões da parede acabada são mínimas e dependem do acabamento efetuado. Na versão para gesso cartonado, foi considerada a aplicação de uma placa de BA13 de cada lado da estrutura. Na versão para alvenaria, recomenda-se a aplicação de uma camada mínima de reboco com 15mm de cada lado da estrutura. A espessura final da parede depende da quantidade de reboco aplicado e do revestimento final (ex.: azulejo).

A espessura máxima da porta já inclui bites ou outros elementos decorativos.

- In the thickness chart, the finished wall dimensions are minimum dimensions and they depend on the finish type. In the plasterboard version, we considered the installation of a single BA13 sheet on each side of the wall structure. In the mortar version, we recommend the application of a 15 mm mortar layer on each side of the wall structure. The final wall thickness depends on the quantity of mortar applied and the final wall covering (ex.: tile)

The maximum door thickness includes the moulding and other decorative elements.

- Pour des épaisseurs ci-dessous, les dimensions du mur fini sont minimales et dépendent de la finition réalisée. Pour la version pour plaques de plâtre, il était considéré l'application d'une plaque de plâtre BA13 de chaque côté de la structure. Pour la version d'enduit, il est recommandé d'appliquer une couche de plâtrage avec un minimum de 15 mm de chaque côté du caisson. L'épaisseur finale du mur dépend de la quantité de la plâtrage appliquée et de la finition appliquée (ex.: carrelage).

L'épaisseur maximale de la porte comprend le moulage et d'autres éléments décoratifs.

DIMENSÕES | DIMENSIONS

CAIXILHO POCKET FRAME CONTRE-CHÂSSIS (LxH)	VÃO LIVRE CLEAR OPENING PASSAGE LIBRE (PLxHL)	VÃO TOTAL DE OBRA OVERALL DIMENSION DIMENSION D'ENCOMBREMENT (LTxHT) **
1200(600+600)x2000	1130x1995	1830x2100
1200(600+600)x2100	1130x2095	1830x2200
1200(600+600)x2400	1130x2395	1830x2500
1400(700+700)x2000	1330x1995	2130x2100
1400(700+700)x2100	1330x2095	2130x2200
1400(700+700)x2400	1330x2395	2130x2500
1500(750+750)x2000	1430x1995	2230x2100
1500(750+750)x2100	1430x2095	2230x2200
1500(750+750)x2400	1430x2395	2230x2500
1600(800+800)x2000	1530x1995	2430x2100
1600(800+800)x2100	1530x2095	2430x2200
1600(800+800)x2400	1530x2395	2430x2500
1800(900+900)x2000	1730x1995	2730x2100
1800(900+900)x2100	1730x2095	2730x2200
1800(900+900)x2400	1730x2395	2730x2500
2000(1000+1000)x2000	1930x1995	3030x2100
2000(1000+1000)x2100	1930x2095	3030x2200
2000(1000+1000)x2400	1930x2395	3030x2500
2200(1100+1100)x2000	2130x1995	3330x2100
2200(1100+1100)x2100	2130x2095	3330x2200
2200(1100+1100)x2400	2130x2395	3330x2500
2400(1200+1200)x2000	2330x1995	3730x2100
2400(1200+1200)x2100	2330x2095	3730x2200
2400(1200+1200)x2400	2330x2395	3730x2500

Cores de Portas e Aros | Consulte catálogo Nº2 PORTAS
Door and Door frame colours | Check Door catalogue Nº2
Couleurs des portes et Huisseries | Consultez catalogue Nº2 Portes

Possibilidade de fabrico por medida
Custom-size frames also possible | Possibilité de fabrication sur mesure

Dimensões em milímetros | Dimensions in millimeters | Dimensions en millimètres

PAREDE EM ALVENARIA
MORTAR WALL | MUR EN ENDUIT

Porta de Madeira | Wooden door | Porte en bois
Aros em madeira | Wooden door frame | Huisserie en bois

Opção | Option

Com guarnição
With Architrave
Avec chambranles

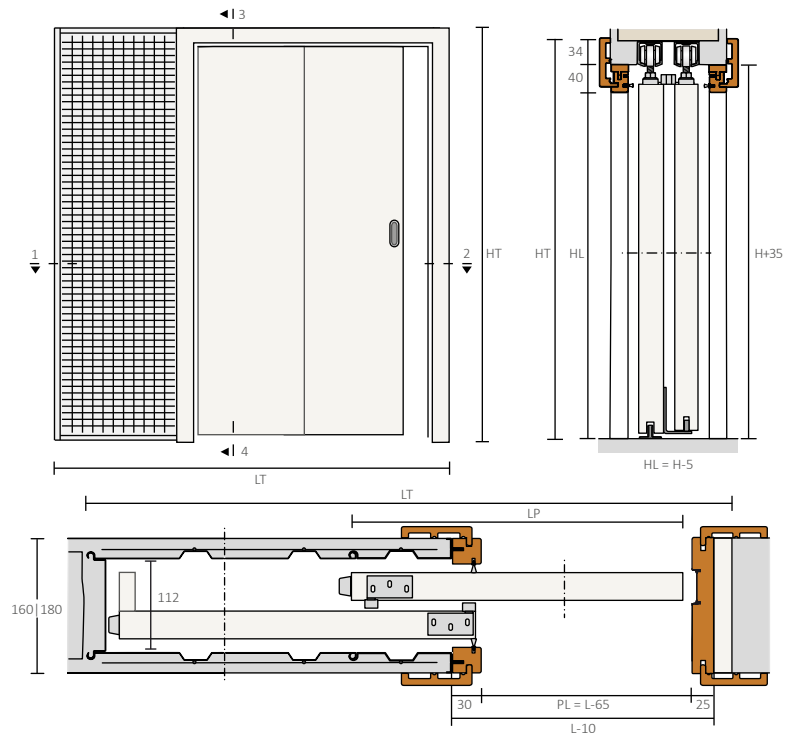

Cálculo para aplicação em obra
On-site application calculator | Calcul pour l'installation sur le chantier

- Dimensão total em obra**
Overall dimensions | Dimension de l'encombrement:
- HT= H+100
 - LT= 3xLP+30

Dimensão da porta
Door dimensions | Dimension de la porte

- Porta de madeira**
Wooden door | Porte en bois:
- HP= H
 - LP= L/2 (min)

PAREDE EM GESSO CARTONADO
PLASTERBOARD WALL | MUR EN PLAQUES DE PLÂTRE

Porta de Madeira | Wooden door | Porte en bois
Aros em madeira | Wooden door frame | Huisserie en bois

Opção | Option

Com guarnição
With Architrave
Avec chambranles

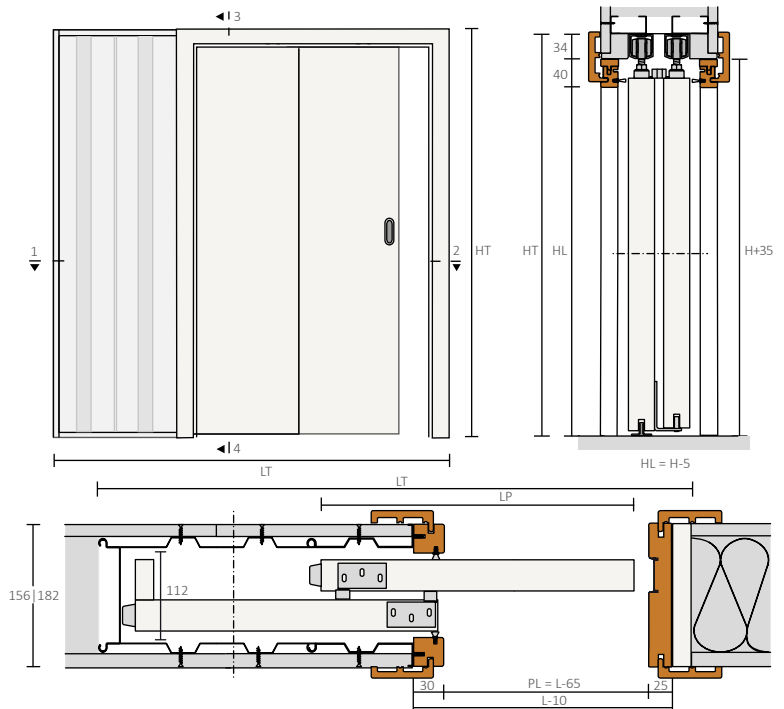

Cálculo para aplicação em obra
On-site application calculator | Calcul pour l'installation sur le chantier

- Dimensão total em obra ****
Overall dimensions | Dimension de l'encombrement:
- HT= H+70
 - LT= 3xLP

Cálculo da dimensão da porta
Door dimensions | Dimension de la porte

- Porta de madeira**
Glass door | Porte en verre:
- HP= H
 - LP= L/2 (min)

** Quando o caixilho é aplicado em paredes de gesso cartonado, o vão total de obra é H+70 X 3xLP
When applied in plasterboard walls, the overall dimension is H+70 X 3xLP
Quand le caisson est installé en mur de plaque de plâtre, la dimension total de l'encombrement est H+70 X 3xLP

H - Altura | Height | Hauteur
HP - Altura da porta | Door height | Hauteur de la porte
HL - Altura livre | Clear height | Hauteur libre
HT - Altura total | Total height | Hauteur total
L - Largura | Width | Largeur
LP - Largura da porta | Door width | Largeur de la porte
PL - Passagem livre | Clear opening | Passage libre
LT - Largura total | Total width | Largeur total



PORTA | Door | Porte



VIDRO
Glass | Verre

BRONZE
Bronze | Bronze



ARO | Frame | Huisserie



MADEIRA
Wood | Bois

HARVEST OAK
Harvest Oak



CONCHA | Flush | Vette

INOX
Steel | Acier

Ref.: 2844

(16)

● Satinado | Satin | Satiné

PARALELO GLASS

O PARALELO GLASS permite a aplicação de duas portas paralelas em vidro, que deslizam sobrepostas e recolhem para um caixilho lateral embutido na parede. Simples e elegante, este sistema foi especialmente desenvolvido para espaços que primam pelo design e funcionalidade.

The PARALELO GLASS enables the installation of two parallel glass doors that slide overlapped and retract into a side pocket frame embedded in the wall.

Simple and elegant, this system was specifically developed for spaces that excel by their design and functionality.

Porta de vidro não comercializada
Glass door not available for sale
Porte en verre indisponible

Le PARALELO GLASS permet l'application de deux portes parallèles en verre, qui coulissent chevauchantes et se recueillent pour un caisson latéral encastré dans la paroi.

Simple et élégant, ce système a été développé spécifiquement pour des espaces qui se distinguent par leur design et fonctionnalité.

Opcional | Optional | Option
EASY SOFT INSIDE

REF:	ALVENARIA MORTAR / ENDUIT	10.1102
	GESSO CARTONADO PLASTERBOARD / PLAQUES DE PLÂTRE	10.1101



ESPESSURAS THICKNESS ÉPAISSEUR				
TIPO DE PAREDE WALL TYPE TYPE DE MUR	INTERIOR DO CAIXILHO POCKET FRAME INTERIOR INTÉRIEUR DU CAISSON	EXTERIOR DO CAIXILHO POCKET FRAME EXTERIOR EXTÉRIEUR DU CAISSON	PAREDE ACABADA FINISHED WALL MUR FINI	ESPESSURA MAX. PORTA MAX. DOOR THICKNESS ÉPAISSEUR MAX. PORTE
ALVENARIA MORTAR ENDUIT	72	90	120	10
GESSO CARTONADO PLASTERBOARD PLAQUES DE PLÂTRE	72	90	116 148 *	10

ARTIGOS INCLuíDOS INCLUDED ITEMS ARTICLES INCLUS:		
1x Caixilho Pocket frame Contre-châssis	2x 9005 Kit acessórios Pocket frame accessories Kit Kit d'accessoires caissons	ALVENARIA MORTAR / ENDUIT
1x Calha em alumínio Aluminium track Rail en aluminium	1x 7012 Kit Paralelo Glass Paralelo Glass Kit Kit Paralelo Glass	4x Redes fibra de vidro Glass fiber mesh Filet de fibre de verre
1x Pré-aro madeira Wood doorpost Pré-cadre bois	2x Distanciador metálico Metallic spacer Entretoise métallique	GESSO CARTONADO PLASTERBOARD / PLAQUES DE PLÂTRE
		Parafusos fosfatados 3.5x19 Phosphated screws Vis phosphatées

EN1527 : 2013
- 6 3 - 1 0 - 1 3

CAPACIDADE MÁXIMA
MAXIMUM CAPACITY / CAPACITÉ MAXIMALE
Porta | Door | Porte
120 Kg



ACESSÓRIOS OPCIONAIS OPTIONAL ACCESSORIES ACCESSOIRES EN OPTION	
	Travão amortecedor Damper stop Frein amortisseur Pag: 51
	Aros em madeira Wooden door frame Huisserie en bois Pag: 56/57
	Abertura simultânea Syncro kit Kit Syncro Pag: 52
	Borracha ajustável A Adjustable rubber seal A Joint butée ajustable Pag: 55
	Borracha adesiva C Adhesive rubber seal C Joint butée adhésif C Pag: 55
	Pinça contínua Continuous clamp Pince continue Pag: 52



* PT Caixilho gesso cartonado L ≥ 900 ou H ≥ 2200 fornecido com travessas de reforço horizontais. Requer a aplicação de 2 placas de gesso BA13 em cada face. Consultar instruções de montagem
EN Pocket frame for Plasterboard L ≥ 900 or H ≥ 2200 supplied with horizontal reinforcement bars. Requires the installation of 2 BA13 plasterboard sheets on each side of the pocket. Check installation guide.
FR Caisson pour plaques de plâtre L ≥ 900 ou H ≥ 2200 fourni avec barres de renfort horizontales. Il requiert l'application de 2 plaques de plâtre BA13 sur chaque côté du caisson. Consultez notice de pose.
PT Tolerância dimensional: 3mm | EN Dimensional tolerance : 3mm | FR Tolérance dimensionnelle: 3 mm

APLICAÇÃO | APPLICATION

- Parede de Alvenaria
Mortar wall | Mur en enduit
- Parede de gesso Cartonado
Plasterboard wall | Mur en plaque de plâtre

OBSERVAÇÕES | NOTES | REMARQUES

■ No quadro de espessuras, as dimensões da parede acabada são mínimas e dependem do acabamento efetuado. Na versão para gesso cartonado, foi considerada a aplicação de uma placa de BA13 de cada lado da estrutura. Na versão para alvenaria, recomenda-se a aplicação de uma camada mínima de reboco com 15mm de cada lado da estrutura. A espessura final da parede depende da quantidade de reboco aplicado e do revestimento final (ex.: azulejo).
A espessura máxima da porta já inclui bites ou outros elementos decorativos.

■ In the thickness chart, the finished wall dimensions are minimum dimensions and they depend on the finish type.
In the plasterboard version, we considered the installation of a single BA13 sheet on each side of the wall structure.
In the mortar version, we recommend the application of a 15 mm mortar layer on each side of the wall structure.
The final wall thickness depends on the quantity of mortar applied and the final wall covering (ex.: tile)

The maximum door thickness includes the moulding and other decorative elements.

■ Pour des épaisseurs ci-dessous, les dimensions du mur fini sont minimales et dépendant de la finition réalisée.
Pour la version pour plaques de plâtre, il était considéré l'application d'une plaque de plâtre BA13 de chaque côté de la structure. Pour la version d'enduit, il est recommandé d'appliquer une couche de plâtrage avec un minimum de 15 mm de chaque côté du caisson.
L'épaisseur finale du mur dépend de la quantité de la plâtrage appliquée et de la finition appliquée (ex.: carrelage).

L'épaisseur maximale de la porte comprend le moulage et d'autres éléments décoratifs.

DIMENSÕES | DIMENSIONS

CAIXILHO POCKET FRAME CONTRE-CHÂSSIS (LxH)	VÃO LIVRE CLEAR OPENING PASSAGE LIBRE (PLxHL)	VÃO TOTAL DE OBRA OVERALL DIMENSION DIMENSION D'ENCOMBREMENT (LTxHT) **
1200 (600+600)x2000	955x1975	1790x2100
1200 (600+600)x2100	955x2075	1790x2200
1200 (600+600)x2400	955x2375	1790x2500
1400 (700+700)x2000	1155x1975	2090x2100
1400 (700+700)x2100	1155x2075	2090x2200
1400 (700+700)x2400	1155x2375	2090x2500
1500 (750+750)x2000	1255x1975	2240x2100
1500 (750+750)x2100	1255x2075	2240x2200
1500 (750+750)x2400	1255x2375	2240x2500
1600(800+800)x2000	1355x1975	2390x2100
1600(800+800)x2100	1355x2075	2390x2200
1600(800+800)x2400	1355x2375	2390x2500
1800 (900+900)x2000	1555x1975	2690x2100
1800 (900+900)x2100	1555x2075	2690x2200
1800 (900+900)x2400	1555x2375	2690x2500
2000(1000+1000)x2000	1755x1975	2990x2100
2000(1000+1000)x2100	1755x2075	2990x2200
2000(1000+1000)x2400	1755x2375	2990x2500
2200(1100+1100)x2000	1955x1975	3290x2100
2200(1100+1100)x2100	1955x2075	3290x2200
2200(1100+1100)x2400	1955x2375	3290x2500
2400(1200+1200)x2000	2155x1975	3590x2100
2400(1200+1200)x2100	2155x2075	3590x2200
2400(1200+1200)x2400	2155x2375	3590x2500

Cores de Portas e Aros | Consulte catálogo Nº2 PORTAS
Door and Door frame colours | Check Door catalogue Nº2
Couleurs des portes et Huisseries | Consultez catalogue Nº2 Portes

Possibilidade de fabrico por medida
Custom-size frames also possible | Possibilité de fabrication sur mesure

Dimensões em milímetros | Dimensions in millimeters | Dimensions en millimètres

PAREDE EM ALVENARIA
MORTAR WALL | MUR EN ENDUIT

Porta de vidro | Glass door | Porte en verre
Aros em madeira | Wooden door frame | Huisserie en bois

Opção | Option

Com guarnição
With Architrave
Avec chambranles

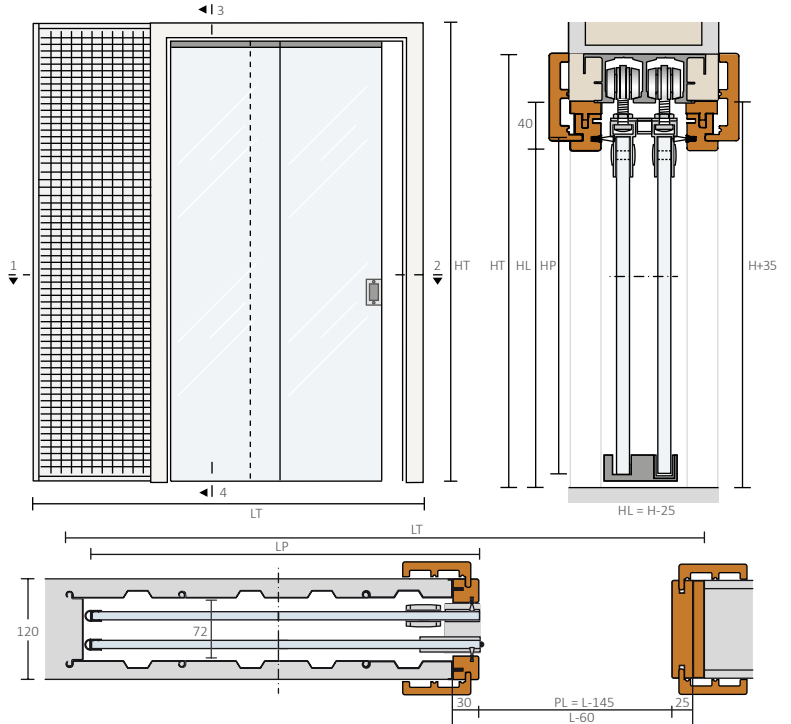

Cálculo para aplicação em obra
On-site application calculator | Calcul pour l'installation sur le chantier

Dimensão da porta
Door dimensions | Dimension de la porte



Dimensão total em obra
Overall dimensions | Dimension de l'encombrement:
■ HT= H+100
■ LT= 3xLP-10



Porta de vidro
Glass door | Porte en verre
■ HP= H-5
■ LP= L/2 +10

PAREDE EM GESSO CARTONADO
PLASTERBOARD WALL | MUR EN PLAQUES DE PLÂTRE

Porta de vidro | Glass door | Porte en verre
Aros em madeira | Wooden door frame | Huisserie en bois

Opção | Option

Com guarnição
With Architrave
Avec chambranles

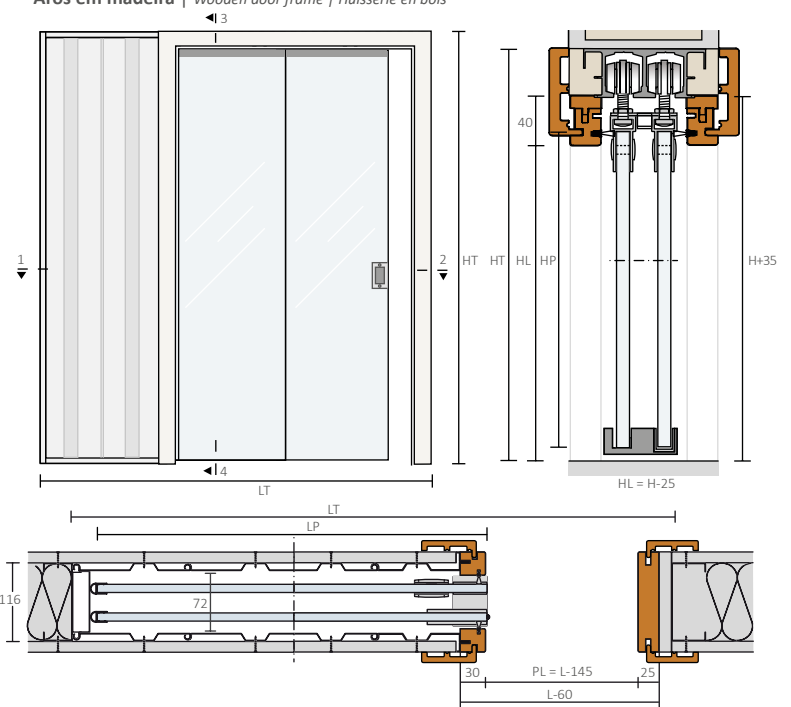

Cálculo para aplicação em obra
On-site application calculator | Calcul pour l'installation sur le chantier

Cálculo da dimensão da porta
Door dimensions | Dimension de la porte



Dimensão total em obra **
Overall dimensions | Dimension de l'encombrement:
■ HT= H+70
■ LT= 3xLP-40



Porta de vidro
Glass door | Porte en verre:
■ HP= H-5
■ LP= L/2 +10

** Quando o caixilho é aplicado em paredes de gesso cartonado, o vão total de obra é H+70 X 3xLP-40
When applied in plasterboard walls, the overall dimension is H+70 X 3xLP-40
Quand le caisson est installé en mur de plaque de plâtre, la dimension total de l'encombrement est H+70 X 3xLP-40

H - Altura | Height | Hauteur
HP - Altura da porta | Door height | Hauteur de la porte
HL - Altura livre | Clear height | Hauteur libre
HT - Altura total | Total height | Hauteur total
L - Largura | Width | Largeur
LP - Largura da porta | Door width | Largeur de la porte
PL - Passagem livre | Clear opening | Passage libre
LT - Largura total | Total width | Largeur total



PORTA | Door | Porte **1V-3FR**

Madeira
Door | Bois

TOLA
Tola | Tola



ARO | Frame | Huisserie **DESIGN**

ALUMÍNIO
Aluminium

LACADO | Lacquered | Laqué
PRETO | Black | Noir



CONCHA | Flush | Vette

INOX | Steel | Acier
Ref.: 2639 (141)
Titânio | Titan

PARALELO WOOD PLUS

O PARALELO WOOD PLUS é uma solução exclusiva para a aplicação de duas portas de correr sobrepostas em madeira de grandes dimensões. Com uma calha dupla embutida no teto, o caixilho PARALELO WOOD PLUS permite separar áreas de grandes dimensões de forma prática e eficaz, mantendo a harmonia do espaço e conferindo-lhe diferentes funcionalidades.

The PARALELO WOOD PLUS is an exclusive solution that enables the use of two overlapping wooden sliding doors of large dimensions. With a double rail embedded on the ceiling, the PARALELO WOOD PLUS pocket frame allows to separate large areas in a practical and effective way, keeping the space harmony and giving it different features.

Optional | Optional | Option
EASYSOFT INSIDE

Le PARALELO WOOD PLUS est une solution exclusive pour l'application de deux portes coulissantes chevauchantes en bois de grandes dimensions. Avec un double rail encastré au plafond, le caisson PARALELO WOOD PLUS permet la séparation des grandes zones d'une façon pratique et effective, en maintenant l'harmonie de l'espace et lui donnant des différentes fonctionnalités.

ACESSÓRIOS OPCIONAIS

OPTIONAL ACCESSORIES | ACCESSOIRES EN OPTION



Travão amortecedor
Damper stop
Frein amortisseur

Pag: 51

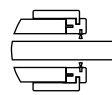

Aros em madeira
Wooden door frame
Huisserie en bois

Pag: 56/57

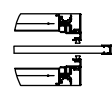

Aros em alumínio
Aluminium door frame
Huisserie en aluminium

Pag: 58/59

REF:	ALVENARIA MORTAR / ENDUIT	10.1302
	GESSO CARTONADO PLASTERBOARD / PLAQUES DE PLÂTRE	10.1301



ESPESSURAS | THICKNESS | ÉPAISSEUR

TIPO DE PAREDE WALL TYPE TYPE DE MUR	INTERIOR DO CAIXILHO POCKET FRAME INTERIOR INTÉRIEUR DU CAISSON	EXTERIOR DO CAIXILHO POCKET FRAME EXTERIOR EXTÉRIEUR DU CAISSON	PAREDE ACABADA FINISHED WALL MUR FINI	ESPESSURA MAX. PORTA MAX. DOOR THICKNESS ÉPAISSEUR MAX. PORTE
ALVENARIA MORTAR ENDUIT	112	130	180	40
GESSO CARTONADO PLASTERBOARD PLAQUES DE PLÂTRE	112	130	188*	40

ARTIGOS INCLuíDOS | INCLUDED ITEMS | ARTICLES INCLUS:

1x Caixilho Pocket frame Contre-châssis	2x 10004 Kit acessórios Pocket frame accessories Kit Kit d'accessoires caisson	ALVENARIA MORTAR ENDUIT 4x Redes fibra de vidro Glass fiber mesh Filet de fibre de verre
1x Calha em alumínio Aluminium track Rail en aluminium	1x 7007 + 7013 Guia inferior porta paralela Floor guide for parallel doors Guide inférieur pour portes parallèles	
1x Pré-aro madeira Wood doorpost Pré-cadre bois	2x Distanciador metálico Metallic spacer Entretoise métallique	GESSO CARTONADO PLASTERBOARD PLAQUES DE PLÂTRE Parafusos fosfatados 3.5x19 Phosphated screws Vis phosphatées

EN1527 : 2013

- 6 3 - 1 0 - 1 3

CAPACIDADE MÁXIMA

MAXIMUM CAPACITY / CAPACITÉ MAXIMALE

Porta | Door | Porte

120 Kg

QR CODE



* PT Caixilho gesso cartonado L ≥ 900 ou H ≥ 2200 fornecido com travessas de reforço horizontais. Requer a aplicação de 2 placas de gesso BA13 em cada face. Consultar instruções de montagem. EN Pocket frame for Plasterboard L ≥ 900 or H ≥ 2200 supplied with horizontal reinforcement bars. Requires the installation of 2 BA13 plasterboard sheets on each side of the pocket. Check installation guide. FR Caisson pour plaques de plâtre L ≥ 900 ou H ≥ 2200 fourni avec barres de renfort horizontales. Il requiert l'application de 2 plaques de plâtre BA13 sur chaque côté du caisson. Consultez notice de pose. PT Tolerância dimensional: 3mm | EN Dimensional tolerance : 3mm | FR Tolérance dimensionnelle: 3 mm

APLICAÇÃO | APPLICATION

- Parede de Alvenaria
Mortar wall | Mur en enduit
- Parede de gesso Cartonado
Plasterboard wall | Mur en plaque de plâtre

OBSERVAÇÕES | NOTES | REMARQUES

- No quadro de espessuras, as dimensões da parede acabada são mínimas e dependem do acabamento efetuado. Na versão para gesso cartonado, foi considerada a aplicação de duas placas de BA13 de cada lado da estrutura. Na versão para alvenaria, recomenda-se a aplicação de uma camada mínima de reboco com 25mm de cada lado da estrutura. A espessura final da parede depende da quantidade de reboco aplicado e do revestimento final (ex.: azulejo).

A espessura máxima da porta já inclui bites ou outros elementos decorativos.

- In the thickness chart, the finished wall dimensions are minimum dimensions and they depend on the finish type. In the plasterboard version, we considered the installation of two BA13 sheet on each side of the wall structure. In the mortar version, we recommend the application of a 25 mm mortar layer on each side of the wall structure. The final wall thickness depends on the quantity of mortar applied and the final wall covering (ex.: tile)

The maximum door thickness includes the moulding and other decorative elements.

- Pour des épaisseurs ci-dessous, les dimensions du mur fini sont minimales et dépendant de la finition réalisée. Pour la version pour plaques de plâtre, il était considéré l'application de deux plaques de plâtre BA13 de chaque côté de la structure. Pour la version d'enduit, il est recommandé d'appliquer une couche de plâtrage avec un minimum de 25 mm de chaque côté du caisson. L'épaisseur finale du mur dépend de la quantité de la plâtrage appliquée et de la finition appliquée (ex.: carrelage).

L'épaisseur maximale de la porte comprend le moulage et d'autres éléments décoratifs.

DIMENSÕES | DIMENSIONS

CAIXILHO POCKET FRAME CONTRE-CHÂSSIS (LxH)	VÃO LIVRE CLEAR OPENING PASSAGE LIBRE (PLxHL)	VÃO TOTAL DE OBRA OVERALL DIMENSION DIMENSION D'ENCOMBREMENT (LTxHT) **
1200(600+600)xH	1130xH	1860xH+68
1400(700+700)xH	1320xH	2160xH+68
1500(750+750)xH	1420xH	2310xH+68
1600(800+800)xH	1530xH	2460xH+68
1800(900+900)xH	1730xH	2760xH+68
2000(1000+1000)xH	1930xH	3060xH+68
2200(1100+1100)xH	2130xH	3360xH+68
2400(1200+1200)xH	2330xH	3660xH+68
2800(1400+1400)xH	2730xH	4260xH+68

Fabrico por medida
Made by order | Fabrication sur mesure

Dimensão máxima
Maximum dimension | Dimension maximale
4000x3000 mm

Cores de Portas e Aros | Consulte catálogo N°2 PORTAS
Door and Door frame colours | Check Door catalogue N°2
Couleurs des portes et Huisseries | Consultez catalogue N°2 Portes

- Viga em madeira para reduzir vibrações no teto falso (não fornecido)
Wooden beam to reduce the false ceiling vibrations (not supplied)
Poutre en bois pour réduire les vibrations du faux plafond (Non fourni)

Dimensões em milímetros | Dimensions in millimeters | Dimensions en millimètres

PAREDE EM ALVENARIA
MORTAR WALL | MUR EN ENDUIT

Porta de Madeira | Wooden door | Porte en bois
Aros em alumínio | Aluminium door frame | Huisserie en aluminium

Opção | Option

Com guarnição
With Architrave
Avec chambranles

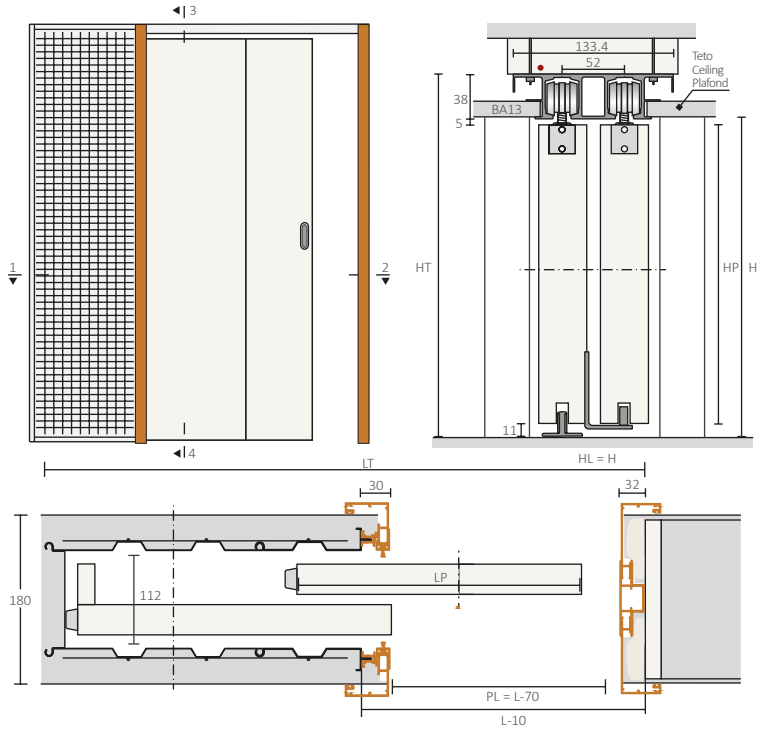

Cálculo para aplicação em obra
On-site application calculator | Calcul pour l'installation sur le chantier

- Dimensão total em obra
Overall dimensions | Dimension de l'encombrement:
- HT= H+68
 - LT= 3xLP+60

Dimensão da porta
Door dimensions | Dimension de la porte

- Porta de madeira
Wooden door | Porte en bois:
- HP= H-16
 - LP= L/2

PAREDE EM GESSO CARTONADO
PLASTERBOARD WALL | MUR EN PLAQUES DE PLÂTRE

Porta de Madeira | Wooden door | Porte en bois
Aros em alumínio | Aluminium door frame | Huisserie en aluminium

Opção | Option
DESIGN

Sem guarnição
Without Architrave
Sans chambranle

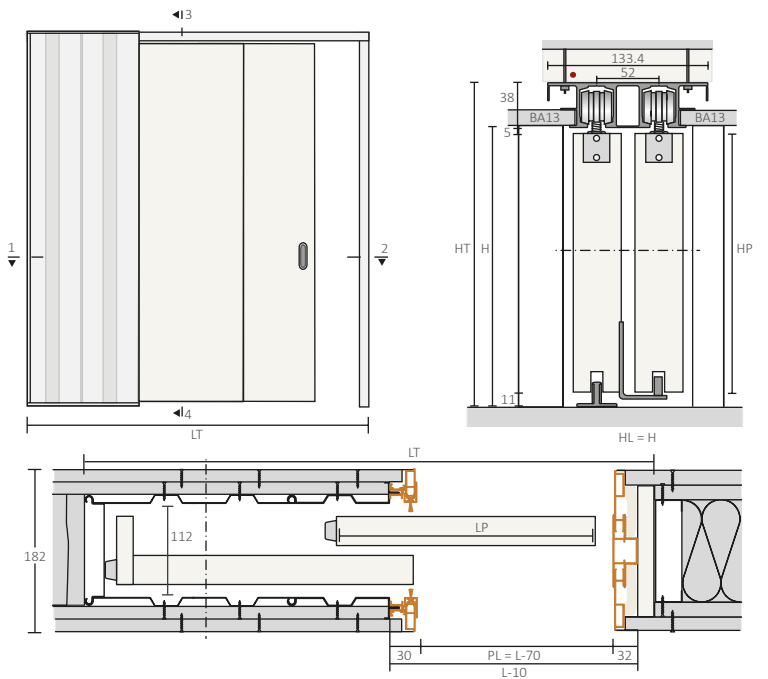

Cálculo para aplicação em obra
On-site application calculator | Calcul pour l'installation sur le chantier

- Dimensão total em obra **
Overall dimensions | Dimension de l'encombrement:
- HT= H+38
 - LT= 3xLP+30

Cálculo da dimensão da porta
Door dimensions | Dimension de la porte

- Porta de madeira
Wooden door | Porte en bois:
- HP= H-16
 - LP= L/2



PORTA | Door | Porte



VIDRO
Glass | Verre

Fosco
Frosted | Dépoli



ARO | Frame | Huisserie



ALUMÍNIO
Aluminium

LACADO | Lacquered | Laqués
BRANCO | White | Blanc

DESIGN

CONCHA | Flush | Vette



INOX
Steel | Acier

Ref.: 2653 (16)
Satinado | Satin | Satiné

PARALELO GLASS PLUS

Desenvolvido para ambientes requintados, o PARALELO GLASS PLUS permite a utilização de duas portas de correr em vidro de grandes dimensões, que correm sobrepostas para o mesmo caixilho lateral.

A calha dupla embutida no teto da versão PLUS do PARALELO GLASS possibilita a divisão de espaços com áreas generosas de forma discreta e funcional, mantendo a amplitude dos espaços e promovendo a sua versatilidade.

Designed for exquisite spaces, the PARALELO GLASS PLUS allows the use of two large glass sliding doors that slide overlapped to the same side pocket frame.

The PLUS double in-ceiling track of PARALELO GLASS pocket frame enables the division generous sized spaces in a discrete and functional way, preserving the room amplitude and its versatility.

Porta de vidro não comercializada
Glass door not available for sale
Porte en verre indisponible

Conçu pour les décors exquises, le PARALELO GLASS PLUS permet l'utilisation de deux portes coulissantes en verre de grandes dimensions, qui coulent chevauchantes pour le même caisson latéral.

Le double rail encastré au plafond de la version PLUS du PARALELO GLASS fait la division des espaces aux dimensions généreuses de sorte discrète et fonctionnelle, maintenant l'amplitude des espaces et promouvant leur polyvalence.

Opcional | Optional | Option
EASY SOFT INSIDE

REF:	ALVENARIA MORTAR / ENDUIT	10.1402
	GESSO CARTONADO PLASTERBOARD / PLAQUES DE PLÂTRE	10.1401



ESPESSURAS THICKNESS ÉPAISSEUR				
TIPO DE PAREDE WALL TYPE TYPE DE MUR	INTERIOR DO CAIXILHO POCKET FRAME INTERIOR INTÉRIEUR DU CAISSON	EXTERIOR DO CAIXILHO POCKET FRAME EXTERIOR EXTÉRIEUR DU CAISSON	PAREDE ACABADA FINISHED WALL MUR FINI	ESPESSURA MAX. PORTA MAX. DOOR THICKNESS ÉPAISSEUR MAX. PORTE
ALVENARIA MORTAR ENDUIT	72	90	140	10
GESSO CARTONADO PLASTERBOARD PLAQUES DE PLÂTRE	72	90	148*	10

ARTIGOS INCLUÍDOS INCLUDED ITEMS ARTICLES INCLUS:			
1x Caixilho Pocket frame Contre-châssis	2x 9005 Kit acessórios Pocket frame accessories Kit Kit d'accessoires caissons		ALVENARIA MORTAR ENDUIT
1x Calha em alumínio Aluminium track Rail en aluminium	1x 7012 Kit Paralelo Glass Paralelo Glass Kit Kit Paralelo Glass		4x Redes fibra de vidro Glass fiber mesh Filet de fibre de verre
1x Pré-aro madeira Wood doorpost Pré-cadre bois	Distanciador metálico Metallic spacer Entretoise métallique		GESSO CARTONADO PLASTERBOARD PLAQUES DE PLÂTRE
			Parafusos fosfatados 3.5x19 Phosphated screws Vis phosphatées

EN1527 : 2013
- 6 3 - 1 0 - 1 3

CAPACIDADE MÁXIMA
MAXIMUM CAPACITY / CAPACITÉ MAXIMALE
Porta | Door | Porte
120 Kg



ACESSÓRIOS OPCIONAIS OPTIONAL ACCESSORIES | ACCESSOIRES EN OPTION



Travão amortecedor
Damper stop
Frein amortisseur

Pag: 51



Aros em madeira
Wooden door frame
Huisserie en bois

Pag: 56/57



Aros em alumínio
Aluminium door frame
Huisserie en aluminium

Pag: 58/59



Pinça contínua
Continuous clamp
Pince continue

Pag: 52



Borracha ajustável A
Adjustable rubber seal A
Joint butée ajustable

Pag: 55



Borracha adesiva C
Adhesive rubber seal C
Joint butée adhésif C

Pag: 55



* PT Caixilho gesso cartonado L ≥ 900 ou H ≥ 2200 fornecido com travessas de reforço horizontais. Requer a aplicação de 2 placas de gesso BA13 em cada face. Consultar instruções de montagem.
EN Pocket frame for Plasterboard L ≥ 900 or H ≥ 2200 supplied with horizontal reinforcement bars. Requires the installation of 2 BA13 plasterboard sheets on each side of the pocket. Check installation guide.
FR Caisson pour plaques de plâtre L ≥ 900 ou H ≥ 2200 fourni avec barres de renfort horizontales. Il requiert l'application de 2 plaques de plâtre BA13 sur chaque côté du caisson. Consultez notice de pose.
PT Tolerância dimensional: 3mm | EN Dimensional tolerance : 3mm | FR Tolérance dimensionnelle: 3 mm

APLICAÇÃO | APPLICATION

- Parede de Alvenaria
Mortar wall | Mur en enduit
- Parede de gesso Cartonado
Plasterboard wall | Mur en plaque de plâtre

OBSERVAÇÕES | NOTES | REMARQUES

■ No quadro de espessuras, as dimensões da parede acabada são mínimas e dependem do acabamento efetuado. Na versão para gesso cartonado, foi considerada a aplicação de duas placas de BA13 de cada lado da estrutura. Na versão para alvenaria, recomenda-se a aplicação de uma camada mínima de reboco com 25mm de cada lado da estrutura. A espessura final da parede depende da quantidade de reboco aplicado e do revestimento final (ex.: azulejo).

A espessura máxima da porta já inclui bites ou outros elementos decorativos.

■ In the thickness chart, the finished wall dimensions are minimum dimensions and they depend on the finish type. In the plasterboard version, we considered the installation of two BA13 sheet on each side of the wall structure. In the mortar version, we recommend the application of a 25 mm mortar layer on each side of the wall structure. The final wall thickness depends on the quantity of mortar applied and the final wall covering (ex.: tile)

The maximum door thickness includes the moulding and other decorative elements.

■ Pour des épaisseurs ci-dessous, les dimensions du mur fini sont minimales et dépendent de la finition réalisée. Pour la version pour plaques de plâtre, il était considéré l'application de deux plaques de plâtre BA13 de chaque côté de la structure. Pour la version d'enduit, il est recommandé d'appliquer une couche de plâtrage avec un minimum de 25 mm de chaque côté du caisson. L'épaisseur finale du mur dépend de la quantité de la plâtrage appliquée et de la finition appliquée (ex.: carrelage).

L'épaisseur maximale de la porte comprend le moulage et d'autres éléments décoratifs.

DIMENSÕES | DIMENSIONS

CAIXILHO POCKET FRAME CONTRE-CHÂSSIS (LxH)	VÃO LIVRE CLEAR OPENING PASSAGE LIBRE (PLxHL)	VÃO TOTAL DE OBRA OVERALL DIMENSION DIMENSION D'ENCOMBREMENT (LTxHT) **
1200(600+600)xH	955xH	1790xH+68
1400(700+700)xH	1155xH	2090xH+68
1500(750+750)xH	1255xH	2240xH+68
1600(800+800)xH	1355xH	2390xH+68
1800(900+900)xH	1555xH	2690xH+68
2000(1000+1000)xH	1755xH	2990xH+68
2200(1100+1000)xH	1955xH	3290xH+68
2400(1200+1200)xH	2155xH	3590xH+68
2800(1400+1400)xH	2355xH	4190xH+68

Dimensão máxima
Maximum dimension | Dimension maximale
2800x3000 mm

Cores de Portas e Aros | Consulte catálogo N°2 PORTAS
Door and Door frame colours | Check Door catalogue N°2
Couleurs des portes et Huisseries | Consultez catalogue N°2 Portes

• Viga em madeira para reduzir vibrações no teto falso (não fornecido)
Wooden beam to reduce the false ceiling vibrations (not supplied)
Poutre en bois pour réduire les vibrations du faux plafond (Non fourni)

Possibilidade de fabrico por medida
Custom-size frames also possible | Possibilité de fabrication sur mesure

Dimensões em milímetros | Dimensions in millimeters | Dimensions en millimètres

PAREDE EM ALVENARIA
MORTAR WALL | MUR EN ENDUIT

Porta de vidro | Glass door | Porte en verre

Opção | Option

Com guarnição
With Architrave
Avec chambranles

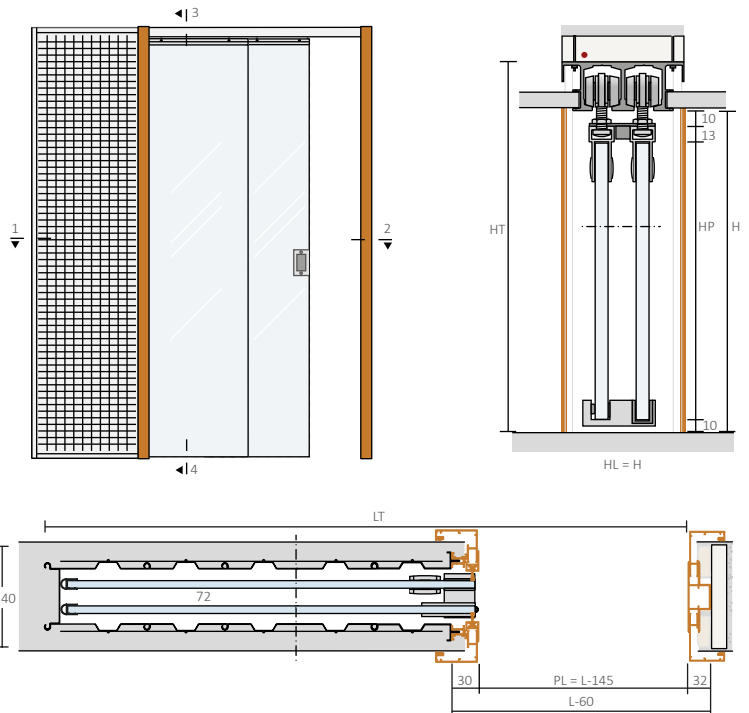

Cálculo para aplicação em obra
On-site application calculator | Calcul pour l'installation sur le chantier

Dimensão total em obra
Overall dimensions | Dimension de l'encombrement:
 ■ HT= H+68
 ■ LT= 3xLP-10

Dimensão da porta
Door dimensions | Dimension de la porte

Porta de vidro
Glass door | Porte en verre:
 ■ HP= H-33
 ■ LP= L/2-10

PAREDE EM GESSO CARTONADO
PLASTERBOARD WALL | MUR EN PLAQUES DE PLÂTRE

Porta de vidro | Glass door | Porte en verre
Aros em alumínio | Aluminium door frame | Huisserie en aluminium

Opção | Option
DESIGN

Sem guarnição
Without Architrave
Sans chambranle

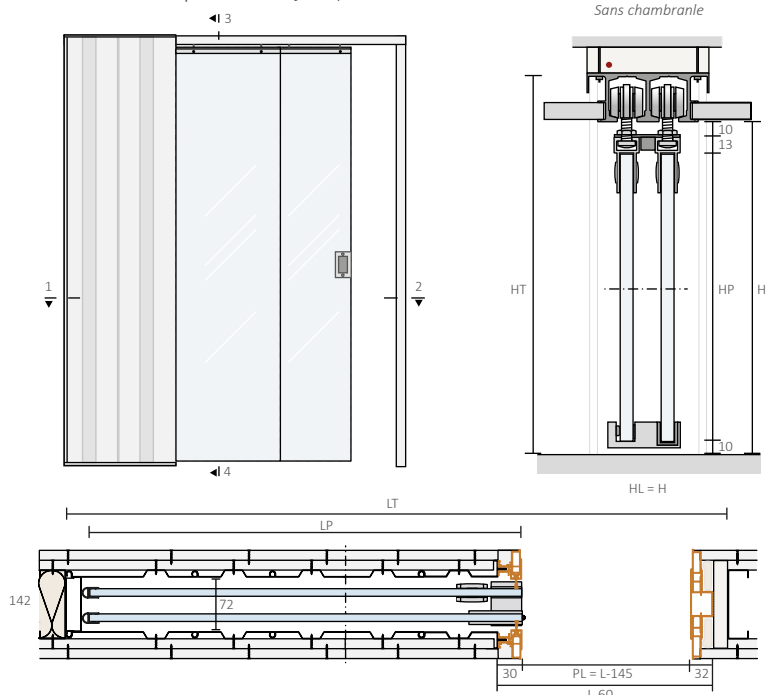

Cálculo para aplicação em obra
On-site application calculator | Calcul pour l'installation sur le chantier

Dimensão total em obra **
Overall dimensions | Dimension de l'encombrement:
 ■ HT= H+38
 ■ LT= 3xLP-40

Cálculo da dimensão da porta
Door dimensions | Dimension de la porte

Porta de vidro
Glass door | Porte en verre:
 ■ HP= H-33
 ■ LP= L/2-10

** Quando o caixilho é aplicado em paredes de gesso cartonado, o vão total de obra é H+38 X 3xLP-40
When applied in plasterboard walls, the overall dimension is H+38 X 3xLP-40
Quand le caisson est installé en mur de plaque de plâtre, la dimension total de l'encombrement est H+38 X 3xLP-40

H - Altura | Height | Hauteur
HP - Altura da porta | Door height | Hauteur de la porte
HL - Altura livre | Clear height | Hauteur libre
HT - Altura total | Total height | Hauteur total
L - Largura | Width | Largeur
LP - Largura da porta | Door width | Largeur de la porte
PL - Passagem livre | Clear opening | Passage libre
LT - Largura total | Total width | Largeur total



PORTA | Door | Porte



MADEIRA
Wood | Bois

NOGUEIRA CACAO
Cacao Walnut | Noyer Cacao



ARO | Frame | Huisserie



MADEIRA
Wood | Bois

NOGUEIRA CACAO
Cacao Walnut | Noyer Cacao



INOX
Steel | Acier



Ref. 2849 (141)
Titânio | Titan

INVERSO

Inovador e prático, o sistema INVERSO foi criado a pensar na otimização do espaço, através da instalação de um caixilho central com duas portas de correr em dois ambientes distintos. Perfeito para quartos, casas de banho ou qualquer espaço contíguo.

Innovative and practical, the INVERSO system was designed thinking in space optimization, by installing a central pocket frame with two opposite sliding doors in two different environments. Perfect for bedrooms, bathrooms or any contiguous space.

Innovant et pratique, le système INVERSO permet l'optimisation de l'espace, à travers de la mise en place d'un caisson central avec deux portes coulissantes opposées en deux environnements différents. Parfait pour des chambres, salles de bains et tous les types d'espaces contigus.

REF:	ALVENARIA MORTAR / ENDUIT	10.1503
	GESSO CARTONADO PLASTERBOARD / PLAQUES DE PLÂTRE	10.1501



ESPESSURAS | THICKNESS | ÉPAISSEUR

TIPO DE PAREDE WALL TYPE TYPE DE MUR	INTERIOR DO CAIXILHO POCKET FRAME INTERIOR INTÉRIEUR DU CAISSON	EXTERIOR DO CAIXILHO POCKET FRAME EXTERIOR EXTÉRIEUR DU CAISSON	PAREDE ACABADA FINISHED WALL MUR FINI	ESPESSURA MAX. PORTA MAX. DOOR THICKNESS ÉPAISSEUR MAX. PORTE
ALVENARIA MORTAR ENDUIT	112	130	160	40
GESSO CARTONADO PLASTERBOARD PLAQUES DE PLÂTRE	112	130	156 188 * [△]	40

ARTIGOS INCLuíDOS | INCLUDED ITEMS | ARTICLES INCLUS:

1x Caixilho Pocket frame Contre-châssis	2x 10002 Kit acessórios Pocket frame accessories Kit Kit d'accessoires caissons	ALVENARIA MORTAR / ENDUIT	
1x Calha em alumínio Aluminium track Rail en aluminium	2x Distanciador metálico Metallic spacer Entretoise métallique		4x Redes fibra de vidro Glass fiber mesh Filet de fibre de verre
1x Pré-aro madeira Wood doorpost Pré-cadre bois			GESSO CARTONADO PLASTERBOARD / PLAQUES DE PLÂTRE
		Parafusos fosfatados 3.5x19 Phosphated screws Vis phosphatées	

EN1527 : 2013

- 6 2 - 1 0 - 1 3

CAPACIDADE MÁXIMA
MAXIMUM CAPACITY / CAPACITÉ MAXIMALE

Porta | Door | Porte

80 Kg

QR CODE



ACESSÓRIOS OPCIONAIS

OPTIONAL ACCESSORIES | ACCESSOIRES EN OPTION



Travão amortecedor
Damper stop
Frein amortisseur

Pag: 51

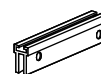

Pinça contínua
Continuous clamp
Pince continue

Pag: 52

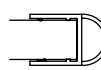

Borracha ajustável A
Adjustable rubber seal A
Joint butée ajustable

Pag: 55

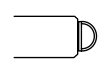

Borracha adesiva C
Adhesive rubber seal C
Joint butée adhésif C

Pag: 55

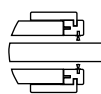

Aros em madeira
Wooden door frame
Huisserie en bois

Pag: 56/57



Perfil PVC 7014
PVC profile
Profil PVC

Pag: 54



* PT Caixilho gesso cartonado L ≥ 900 ou H ≥ 2200 fornecido com travessas de reforço horizontais. Requer a aplicação de 2 placas de gesso BA13 em cada face. Consultar instruções de montagem.
EN Pocket frame for Plasterboard L ≥ 900 or H ≥ 2200 supplied with horizontal reinforcement bars. Requires the installation of 2 BA13 plasterboard sheets on each side of the pocket. Check installation guide.
FR Caisson pour plaques de plâtre L ≥ 900 ou H ≥ 2200 fourni avec barres de renfort horizontales. Il requiert l'application de 2 plaques de plâtre BA13 sur chaque côté du caisson. Consultez notice de pose.
PT Tolerância dimensional: 3mm | EN Dimensional tolerance : 3mm | FR Tolérance dimensionnelle: 3 mm

APLICAÇÃO | APPLICATION

- Parede de Alvenaria
Mortar wall | Mur en enduit
- Parede de gesso Cartonado
Plasterboard wall | Mur en plaque de plâtre

OBSERVAÇÕES | NOTES | REMARQUES

■ No quadro de espessuras, as dimensões da parede acabada são mínimas e dependem do acabamento efetuado. Na versão para gesso cartonado, foi considerada a aplicação de uma placa de BA13 de cada lado da estrutura. Na versão para alvenaria, recomenda-se a aplicação de uma camada mínima de reboco com 15mm de cada lado da estrutura. A espessura final da parede depende da quantidade de reboco aplicado e do revestimento final (ex.: azulejo).

A espessura máxima da porta já inclui bites ou outros elementos decorativos.

■ In the thickness chart, the finished wall dimensions are minimum dimensions and they depend on the finish type. In the plasterboard version, we considered the installation of a single BA13 sheet on each side of the wall structure. In the mortar version, we recommend the application of a 15 mm mortar layer on each side of the wall structure. The final wall thickness depends on the quantity of mortar applied and the final wall covering (ex.: tile)

The maximum door thickness includes the moulding and other decorative elements.

■ Pour des épaisseurs ci-dessous, les dimensions du mur fini sont minimales et dépendant de la finition réalisée. Pour la version pour plaques de plâtre, il était considéré l'application d'une plaque de plâtre BA13 de chaque côté de la structure. Pour la version d'enduit, il est recommandé d'appliquer une couche de plâtrage avec un minimum de 15 mm de chaque côté du caisson. L'épaisseur finale du mur dépend de la quantité de la plâtrage appliquée et de la finition appliquée (ex.: carrelage).

L'épaisseur maximale de la porte comprend le moulage et d'autres éléments décoratifs.

DIMENSÕES | DIMENSIONS

CAIXILHO POCKET FRAME CONTRE-CHÂSSIS (LxH)	VÃO LIVRE CLEAR OPENING PASSAGE LIBRE (PLxHL)	VÃO TOTAL DE OBRA OVERALL DIMENSION DIMENSION D'ENCOMBREMENT (LTxHT) **
1200(600+600)x2000	575x1995	1950x2100
1200(600+600)x2100	575x2095	1950x2200
1200(600+600)x2400	575x2395	1950x2500
1400(700+700)x2000	675x1995	2250x2100
1400(700+700)x2100	675x2095	2250x2200
1400(700+700)x2400	675x2395	2250x2500
1500(750+750)x2000	725x1995	2400x2100
1500(750+750)x2100	725x2095	2400x2200
1500(750+750)x2400	725x2395	2400x2500
1600(800+800)x2000	775x1995	2550x2100
1600(800+800)x2100	775x2095	2550x2200
1600(800+800)x2400	775x2395	2550x2500
1800(900+900)x2000	875x1995	2850x2100
1800(900+900)x2100	875x2095	2850x2200
1800(900+900)x2400	875x2395	2850x2500
2000(1000+1000)x2000	975x1995	3150x2100
2000(1000+1000)x2100	975x2095	3150x2200
2000(1000+1000)x2400	975x2395	3150x2500
2200(1100+1100)x2000	1075x1995	3450x2100
2200(1100+1100)x2100	1075x2095	3450x2200
2200(1100+1100)x2400	1075x2395	3450x2500
2400(1200+1200)x2000	1175x1995	3750x2100
2400(1200+1200)x2100	1175x2095	3750x2200
2400(1200+1200)x2400	1175x2395	3750x2500

Cores de Portas e Aros | Consulte catálogo Nº2 PORTAS
Door and Door frame colours | Check Door catalogue Nº2
Couleurs des portes et Huisseries | Consultez catalogue Nº2 Portes

Possibilidade de fabrico por medida
Custom-size frames also possible | Possibilité de fabrication sur mesure

Dimensões em milímetros | Dimensions in millimeters | Dimensions en millimètres

PAREDE EM ALVENARIA
MORTAR WALL | MUR EN ENDUIT

Porta de Madeira | Wooden door | Porte en bois
Aros em madeira | Wooden door frame | Huisserie en bois

Opção | Option

Com guarnição
With Architrave
Avec chambranles

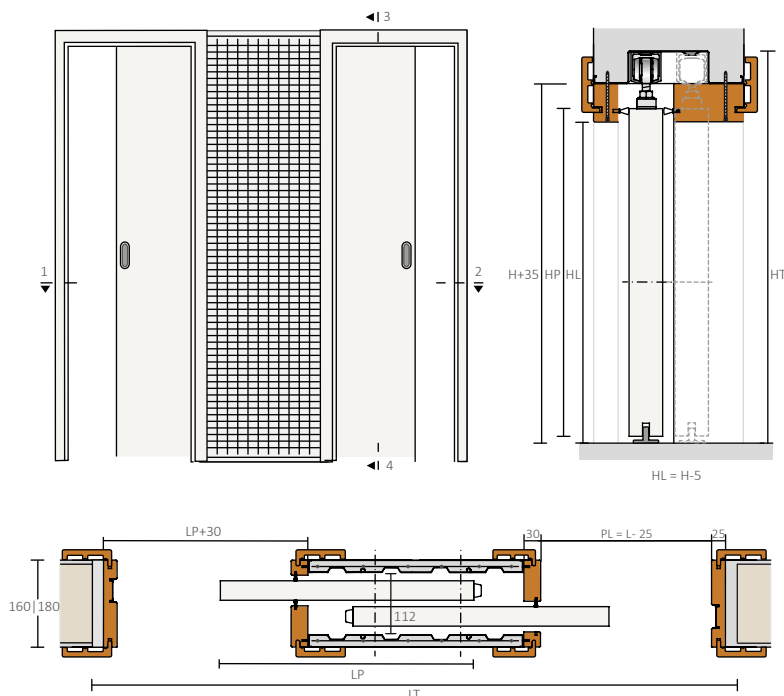

Cálculo para aplicação em obra
On-site application calculator | Calcul pour l'installation sur le chantier

Dimensão total em obra
Overall dimensions | Dimension de l'encombrement:
 ■ HT= H+100
 ■ LT= 3xLP+150

Dimensão da porta
Door dimensions | Dimension de la porte

Porta de madeira
Wooden door | Porte en bois:
 ■ HP= H
 ■ LP= L/2

PAREDE EM GESSO CARTONADO
PLASTERBOARD WALL | MUR EN PLAQUES DE PLÂTRE

Porta de vidro | Glass door | Porte en verre
Aros em madeira | Wooden door frame | Huisserie en bois

Opção | Option

Com guarnição
With Architrave
Avec chambranles

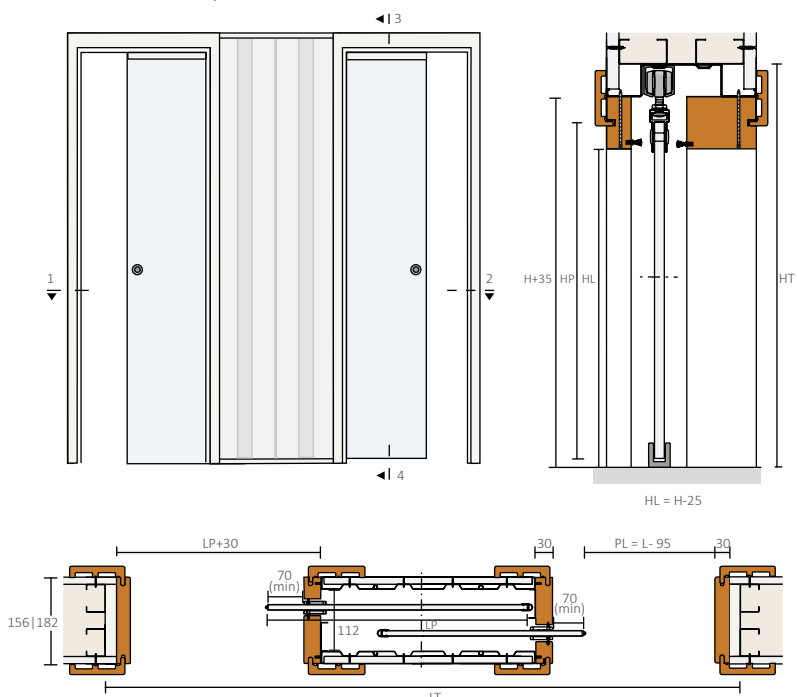

Cálculo para aplicação em obra
On-site application calculator | Calcul pour l'installation sur le chantier

Dimensão total em obra **
Overall dimensions | Dimension de l'encombrement:
 ■ HT= H+70
 ■ LT= 3xLP+110

Cálculo da dimensão da porta
Door dimensions | Dimension de la porte

Porta de vidro
Glass door | Porte en verre:
 ■ HP= H
 ■ LP(min)=L/2+85

Easy soft
Easy soft | Easy soft
 HP= H-10*
 LP= L+85

** Quando o caixilho é aplicado em paredes de gesso cartonado, o vão total de obra é H+70 X 3xLP+110
When applied in plasterboard walls, the overall dimension is H+70 X 3xLP+110
Quand le caisson est installé en mur de plaque de plâtre, la dimension total de l'encombrement est H+70 x 3xLP+110

H - Altura | Height | Hauteur
HP - Altura da porta | Door height | Hauteur de la porte
HL - Altura livre | Clear height | Hauteur libre
HT - Altura total | Total height | Hauteur total
L - Largura | Width | Largeur
LP - Largura da porta | Door width | Largeur de la porte
PL - Passagem livre | Clear opening | Passage libre
LT - Largura total | Total width | Largeur total



PORTA | Door | Porte



MADEIRA
Wood | Bois

OLIVE
Olive | Olive

VIDRO Mod. A15
Glass | Verre



CONCHA | Flush | Vette

INOX
Steel | Acier



Ref.:1696 (16)
● **Satinado** | Satin | Satiné



STANDARD

O sistema base da gama EASYKITS permite a aplicação de uma ou duas portas de correr, em madeira ou vidro, com fixação à parede. Simples e elegante, é uma solução económica e funcional para todo o tipo de divisões.





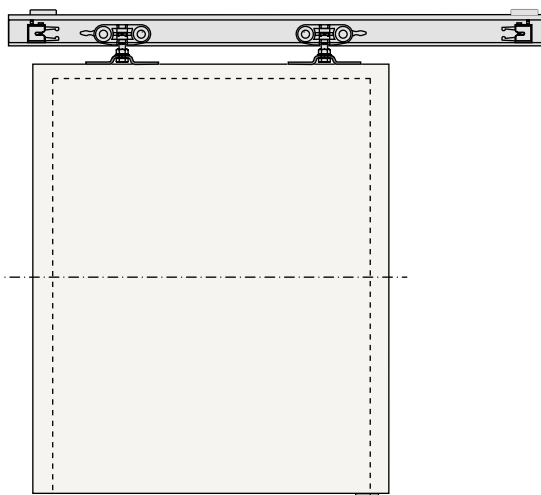

The base model of the EASYKITS range allows the application of a wooden or glass sliding door with a wall mounted system. Simple and elegant, it's a frugal and functional solution for all kinds of spaces.

Le modèle de base de la gamme EASYKITS permet l'application d'une porte coulissante en bois ou en verre avec un système en applique. Simple et élégant, il est une solution économique et fonctionnelle pour toutes sortes de divisions.

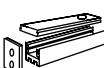
STANDARD 80 KG TRACK NR. 8B RAIL Nº 8B		
 PORTA Door Porte	 KIT KIT	 KIT KIT
600-700	-	2800
750-800	1600	3200
900-1000	2000	4000
1100-1200	2400	4800

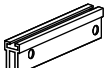
STANDARD 120 KG TRACK NR. 5 RAIL Nº 5		
 PORTA Door Porte	 KIT KIT	 KIT KIT
900-1000	2000	4000
1400-1500	3000	6000

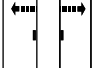

ACESSÓRIOS OPCIONAIS OPTIONAL ACCESSORIES ACCESSOIRES OPTIONNELS	
	Suporte de embutir Embedded door bracket Supporte d'encastrer Pag: 54 
	Pinça contínua Continuous clamp Pince continue Pag: 52 
	Perfil PVC PVC profile Profil PVC Pag: 54 
	Abertura simultânea Syncro kit Kit Syncro Pag: 52 

ARTIGOS INCLUÍDOS INCLUDED ITEMS ARTICLES INCLUS:	
CALHAS TRACKS RAILS	Madeira Wood Bois
8B REF. 1002 	9003 Kit de acessórios 80 kg 80 kg accessories kit Kit d'accessoires 80 kg
5 REF. 1003 	9004 Kit de acessórios 120 kg 120 kg accessories kit Kit d'accessoires 120 kg
	6003 Suporte ajustável 50 mm 50 mm adjustable track bracket Support ajustable 50 mm

CAPACIDADE MÁXIMA
MAXIMUM CAPACITY / CAPACITE MAXIMALE
Porta | Door | Porte
80 | 120 Kg



STANDARD 80 KG - CALHA Nº 8B | TRACK NR 8B | RAIL Nº 8B

EN1527 : 2013

- 6 2 - 1 0 - 1 3

PORTA DE MADEIRA | Wooden door | Porte en bois

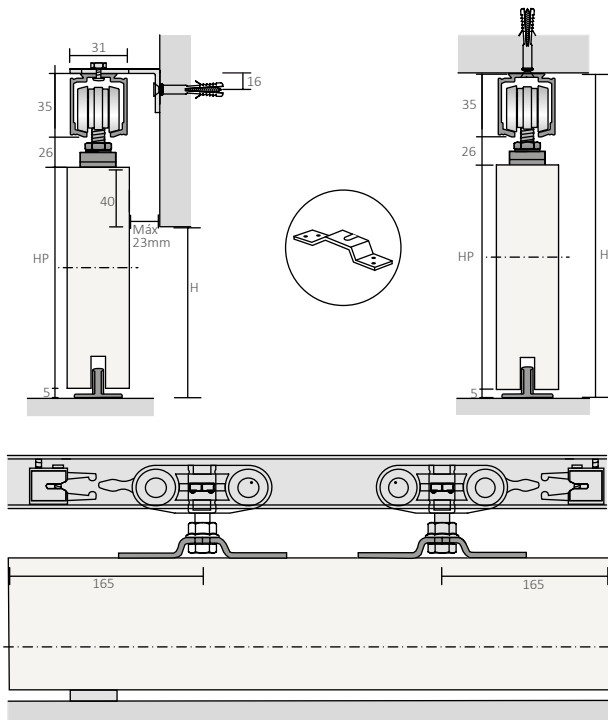

REF. 11.0101.001

PORTA DE VIDRO | Glass door | Porte en verre

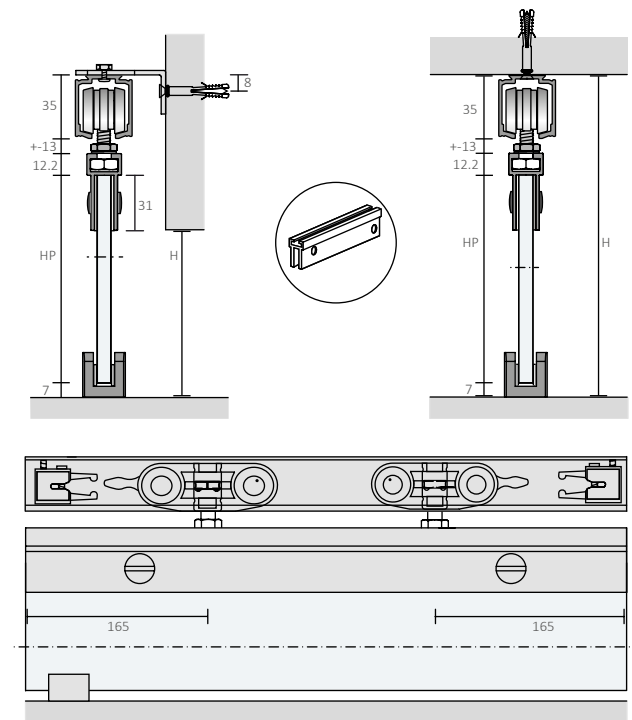

STANDARD 120 KG - CALHA Nº 5 | TRACK NR 5 | RAIL Nº 5

EN1527 : 2013

- 6 3 - 1 0 - 1 3

PORTA DE MADEIRA | Wooden door | Porte en bois

Opcional | Optional | Option
EASY SOFT INSIDE ◀||||||▶

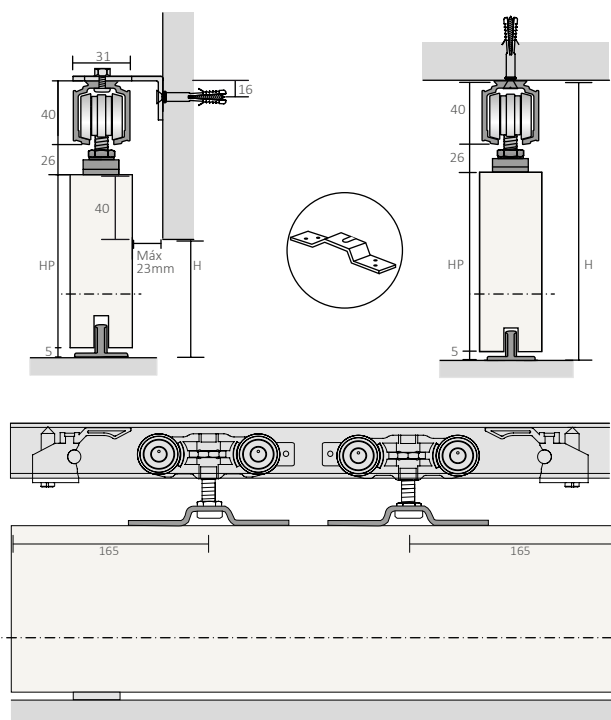

REF. 11.0101.002

PORTA DE VIDRO | Glass door | Porte en verre

Opcional | Optional | Option
EASY SOFT INSIDE ◀||||||▶

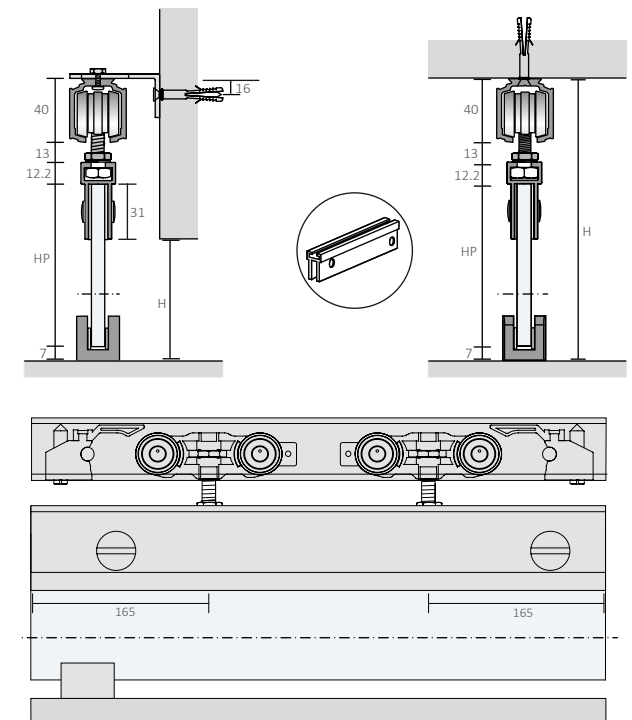



PORTA | Door | Porte **1V**



MADEIRA Zebrano RW
Wood | Bois Zebrano RW



CONCHA | Flush | Vette

INOX
Steel | Acier

Ref.: 2639

(186)

○ Aço Corten | Corten steel | Acier corten

ELEGANCE WOOD

Simple e sofisticado, o sistema ELEGANCE WOOD permite a instalação de uma porta de correr em madeira e a ocultação do sistema com uma aba em alumínio.

De fixação ao teto ou à parede.

Simple and sophisticated, the ELEGANCE WOOD system allows the installation of a wooden sliding door hidden by an aluminium track cover.

Wall or ceiling mounted.

Simple et sophistiqué, le système ELEGANCE WOOD permet l'installation d'une porte coulissante en bois et la dissimulation du système avec un bandeau en aluminium.

Fixation au plafond ou au mur.

ACESSÓRIOS OPCIONAIS
OPTIONAL ACCESSORIES | ACCESSOIRES OPTIONNELS



Perfil PVC
PVC profile
Profil PVC

Pag: 54





Abertura simultânea
Syncro kit
Kit Syncro

Pag: 52



Fixação a parede
Wall mounting | Fixation du mur

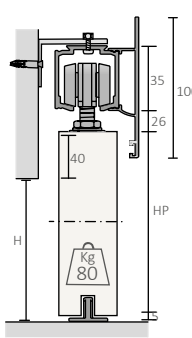

Calha nº8B + Aba nº6
Track nr 8B + Cover nr6 | Rail nº8B + Bandeau nº6

REF: 11.0102.001

EN1527 : 2013
- 6 2 - 1 0 - 1 3

Fixação ao teto
Ceiling mounting | Fixation au plafond

Opcional | Optional | Option
EASY SOFT INSIDE ◀▶

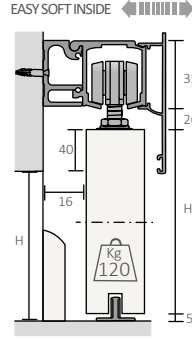

Calha nº14A + Aba nº7
Track nr 14A+ Cover nr7 | Rail nº14A+ Bandeau nº7

REF: 11.0102.003

EN1527 : 2013
- 6 3 - 1 0 - 1 3

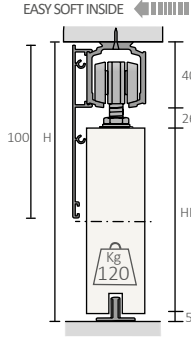

Opcional | Optional | Option
EASY SOFT INSIDE ◀▶



Calha nº5 + Aba nº2
Track nr 5 + Cover nr2 | Rail nº5 + Bandeau nº2

REF: 11.0102.002

EN1527 : 2013
- 6 3 - 1 0 - 1 3

KIT 1 PORTA 1 DOOR KIT KIT 1 PORTE	
 PORTA Door Porte	 KIT
750-800	1600
900-1000	2000
1100-1200	2400
1300-1400	2800

KIT 2 PORTAS 2 DOORS KIT KIT 2 PORTES	
 PORTA Door Porte	 KIT
600-700	2800
750-800	3200
900-1000	4000
1100- 1200	4800

CALHAS TRACKS RAILS	ARTIGOS INCLUÍDOS INCLUDED ITEMS ARTICLES INCLUS:
8B REF. 1002 	9003 Kit de acessórios 80 kg 80 kg accessories kit Kit d'accessoires 80 kg
14A REF. 1008 	9004 Kit de acessórios 120kg 120 kg accessories kit Kit d'accessoires 120 kg
5 REF. 1003	6003 Suportes de parede Wall brackets Supports mur
	Aba nº7 Cover nr 7 Bandeau nº 7
	Aba nº2 Cover nr 2 Bandeau nº 2

CAPACIDADE MÁXIMA
MAXIMUM CAPACITY / CAPACITÉ MAXIMALE
Porta | Door | Porte
80 | 120 Kg





PORTA | Door | Porte

CONCHA | Flush | Vette

VIDRO **FOSCO**
Glass | Verre Frost | Dépoli

INOX **Ref.: 2653 (141)**
Steel | Acier Titânio | Titan

ELEGANCE GLASS

Exclusivo para portas de vidro, o ELEGANCE GLASS é uma solução moderna e funcional para todas as divisões.

De fixação à parede ou ao teto, conjuga a elegância do vidro e a modernismo do alumínio.

Exclusive for glass doors, the ELEGANCE GLASS is a modern and functional solution for every room. With wall or ceiling mounting solutions, this system combines the elegance of the glass with the modernism of the aluminium.

Porta de vidro não comercializada
Glass door not available for sale
Porte en verre indisponible

Exclusif pour des portes en verre, l'ELEGANCE GLASS est une solution moderne et fonctionnelle pour toutes les divisions. Avec fixation murale ou au plafond, ce système allie l'élégance du verre et à la modernité de l'aluminium.

ACESSÓRIOS OPCIONAIS OPTIONAL ACCESSORIES ACCESSOIRES OPTIONNELS	
	Borracha ajustável A Adjustable rubber seal A Joint butée ajustable MOD A Pag: 55
	Borracha adesiva C Adhesive rubber seal C Joint butée adhésif C Pag: 55

Fixação à parede
Wall mounting | Fixation au mur

Opcional | Optional | Option
EASY SOFT INSIDE

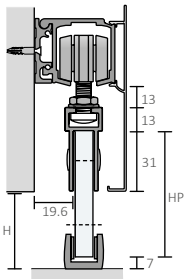

Calha nº14B + Aba nº5

Track nr 14B + Cover nr5 | Rail nº14B + Bandeau nº5

REF: 11.0103.003

EN1527 : 2013

- 6 3 - 1 0 - 1 3

Fixação ao teto
Ceiling mounting | Fixation au plafond

Opcional | Optional | Option
EASY SOFT INSIDE

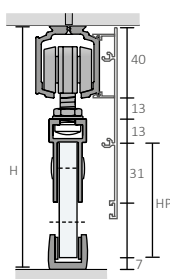

Calha nº5 + Aba nº2

Track nr 5 + Cover nr5 | Rail nº5 + Bandeau nº5

REF: 11.0103.004

EN1527 : 2013

- 6 3 - 1 0 - 1 3

KIT 1 PORTA | 1 DOOR KIT | KIT 1 PORTE

PORTA Door Porte	KIT KIT
750-800	1600
900-1000	2000
1100-1200	2400
1300-1400	2800

KIT 2 PORTAS | 2 DOORS KIT | KIT 2 PORTES

PORTA Door Porte	KIT KIT
600-700	2800
750-800	3200
900-1000	4000
1100-1200	4800

QR CODE



CAPACIDADE MÁXIMA
MAXIMUM CAPACITY / CAPACITÉ MAXIMALE
Porta | Door | Porte
120 Kg

ARTIGOS INCLUÍDOS | INCLUDED ITEMS | ARTICLES INCLUS:

CALHAS TRACKS RAILS		Vidro Glass Verre		1PORTA Door Porte	
14B	R: 1009	Sem Soft Soft Without Sans Soft	1x 9004 Kit de acessórios 120kg 120 kg accessories kit Kit d'accessoires 120 kg	1x 8002 Kit Pinça contínua Continuous clamp kit Kit pince continue	2x Aba nº5 Cover nr5 Bandeau nº5
5	R: 1003	Soft duplo Double Soft	1x 9019 Kit de acessórios 120kg 120 kg accessories kit Kit d'accessoires 120 kg	2x Tampas laterais para abas Side covers Couvercles latérales	



Porta vidro com furação
Door glass with hole
Porte en verre avec trou

H - Altura | Height | Hauteur
HP - Altura da porta | Door height | Hauteur de la porte
FH - Altura do painel fixo | Height fixed panel | Hauteur de panneau fixe

L - Largura | Width | Largeur
LP - Largura da porta | Door width | Largeur de la porte
P - Porta | Door | Porte
PF - Painel Fixo | Fixed panel | Panneau fixe



PORTA | Door | Porte



MADEIRA
Wood | Bois

Carvalho Antiqua
Antiqua Oak | Chenê Antiqua



CONCHA | Flush | Vette

INOX
Steel | Acier

Ref.: 2639 (141)
○ Titânio | Titan

RETRO

O novo modelo RETRO é ideal para criar ambientes distintos e contemporâneos! Destaca-se pela qualidade e robustez do seu sistema de correr, tornando-se versátil na sua aplicação e um elemento diferenciador em qualquer tipo de decoração. Especialmente concebido para os clientes que valorizam a dinâmica estética.

Fixação exclusiva na parede.

The new model RETRO is the ideal solution for creating a distinctive and contemporary environment! It stands out for the quality and robustness of its sliding system, becoming versatile in its application and a differentiating element on any kind of decoration. Specially developed for customers who value aesthetic dynamics.

Exclusive wall mounting system

Le nouveau modèle RETRO est idéal pour créer des environnements distinctifs et contemporains! Il se démarque par la qualité et la robustesse de son système coulissant, en devenant polyvalent dans son application et un élément différenciant dans tout type de décoration. Spécialement conçu pour les clients qui apprécient la dynamique esthétique.

Montage mural exclusif.

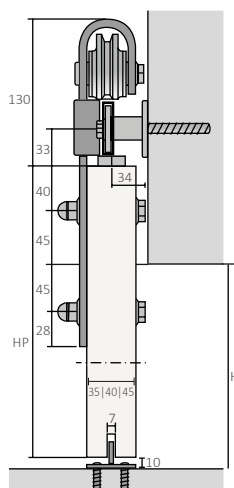
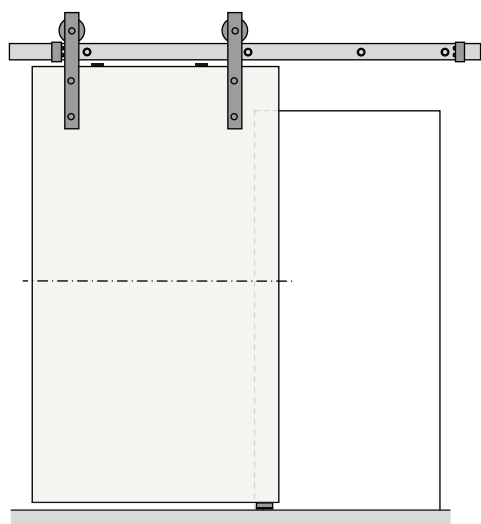

KIT 1 PORTA | 1 DOOR KIT | KIT 1 PORTE



600 - 1000



2000
3000

Incluído | Included | Inclus
EASY SOFT

Necessita de mecanização na porta para aplicar EASY SOFT.
Required Milling for Easy Soft installation.
Usinage nécessaire pour installer Easy Soft.

REF: 11.0120.001

ARTIGOS INCLuíDOS | INCLUDED ITEMS | ARTICLES INCLUS:

1x Barra de Aço
Steel bar
Barre d'acier

1x Kit acessórios
Accessories Kit
Kit d'accessoires

Cores | Cores | Couleurs

P

CAPACIDADE MÁXIMA
MAXIMUM CAPACITY / CAPACITÉ MAXIMALE

Porta | Door | Porte

80 Kg

QR CODE





PORTA | Door | Porte **DUO**

VIDRO | Glass | Verre **ALU** | ALUMÍNIO LACADO | Lacquered | Laqué
Aluminium Preto | Black | Noir

RETRO SLIM

Robusto e moderno, o novo modelo RETRO SLIM evidencia-se pela sua qualidade e dinâmica estética! Seguindo as tendências atuais, trata-se de um sistema de correr que confere personalidade e conforto a qualquer tipo de decoração, sendo cúmplice dos estilos contemporâneo, minimalista, industrial ou até mesmo rústico. Fixação exclusiva na parede.

Sturdy and modern, the new RETRO SLIM stands out for its quality and aesthetic dynamics! Following current trends, it is a sliding door system that provides personality and comfort to any surrounding, being a perfect match in contemporary, minimalist, industrial or even rustic styles. For wall mounting only.

Robuste et moderne, le nouveau modèle RETRO SLIM se distingue par sa qualité et sa dynamique esthétique ! En suivant les tendances actuelles, c'est un système de porte coulissante qui confère personnalité et confort à tout type de décoration, s'accordant parfaitement avec les styles contemporain, minimaliste, industriel ou même rustique. Pour fixation murale seulement .

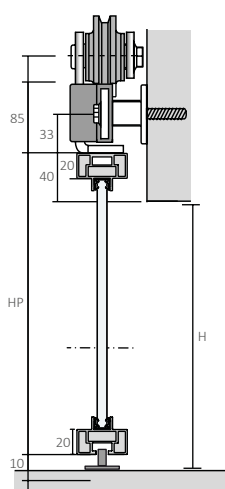
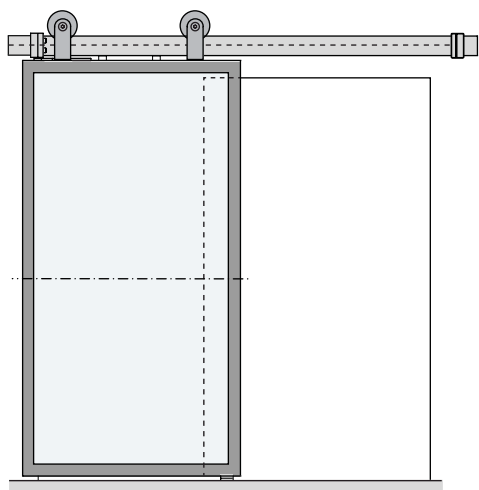

KIT 1 PORTA | 1 DOOR KIT | KIT 1 PORTE

PORTA Door Porte	KIT KIT
600 - 1000	2000
1001 - 1500	3000

Incluído | Included | Inclus
EASYSOFT

Porta de vidro, apenas com moldura de alumínio conforme a imagem! Ver pag. 41 Inside Duo

Glass door only with aluminium frame as shown in photo. (Check page 41 - INSIDE DUO)

Porte en verre seulement avec cadre d'aluminium selon l'image. (Consultez page 41 - INSIDE DUO)

REF: 11.0120.003

QR CODE



Cores | Cores | Couleurs



CAPACIDADE MÁXIMA
MAXIMUM CAPACITY / CAPACITÉ MAXIMALE
Porta | Door | Porte
80 Kg

ARTIGOS INCLuíDOS | INCLUDED ITEMS | ARTICLES INCLUS:

1x Barra de Aço
Steel bar
Barre d'acier

1x Kit acessórios
Accessories Kit
Kit d'accessoires



Madeira
Wood | Bois
35 | 40 | 45



Vidro
Glass | Verre
8 | 10



PRETO
Black
Noir

H - Altura | Height | Hauteur
HP - Altura da porta | Door height | Hauteur de la porte
FH - Altura do painel fixo | Height fixed panel | Hauteur de panneau fixe

L - Largura | Width | Largeur
LP - Largura da porta | Door width | Largeur de la porte
P - Porta | Door | Porte
PF - Painel Fixo | Fixed panel | Panneau fixe



PORTA | Door | Porte



MADEIRA Smoked Oak
Wood | Bois Smoked Oak



CONCHA | Flush | Vette

INOX
Steel | Acier

Ref.: 2639 (141)
○ Titânio | Titan

RETRO MAXI

O novo RETRO MAXI distingue-se pelo seu carisma e estilo absolutamente vanguardista! O seu design robusto e impactante transforma qualquer ambiente numa divisão repleta de imponência, tornando-se no elemento-chave e esteticamente determinante numa habitação. Fixação exclusiva na parede.

The new RETRO MAXI catches the eye by its charisma and avant-garde style! Its sturdy and impactful design transforms any environment into a room full of character becoming the key element and aesthetically determining in a housing. For wall mounting only.

Le nouveau RETRO MAXI se distingue par son charisme et son style absolument avant-gardiste ! Son design robuste et percutant transforme n'importe quel environnement en une pièce pleine de grandeur, devenant l'élément clé et esthétiquement déterminant d'une maison. Pour fixation murale seulement .

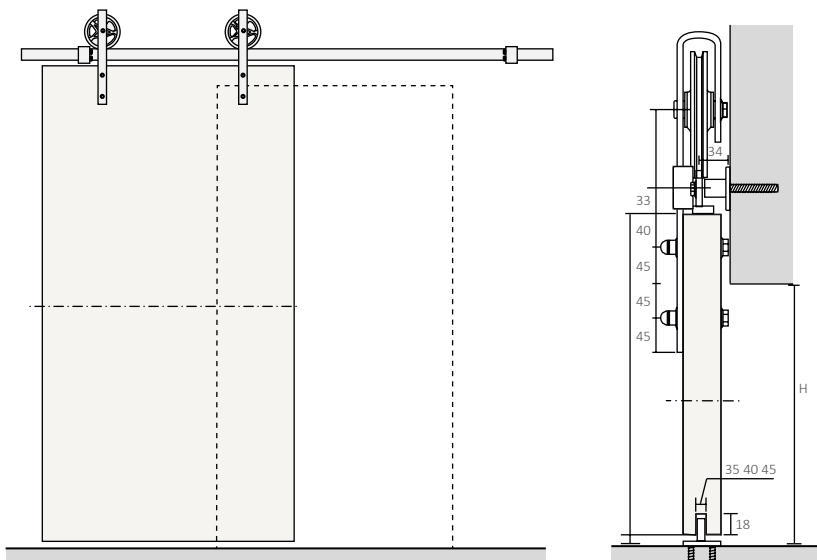

KIT 1 PORTA | 1 DOOR KIT | KIT 1 PORTE

PORTA Door Porte	KIT KIT
600 - 1000	2000
1001 - 1500	3000

Incluído | Included | Inclus
EASY SOFT

Necessita mecanização para colocar Easy Soft
Required Milling for Easy Soft installation
Usinage nécessaire pour installer Easy Soft

REF: 11.0120.004

ARTIGOS INCLuíDOS | INCLUDED ITEMS | ARTICLES INCLUS:

1x Barra de Aço
Steel bar
Barre d'acier

1x Kit acessórios
Accessories Kit
Kit d'accessoires

Cores | Cores | Couleurs



CAPACIDADE MÁXIMA
MAXIMUM CAPACITY / CAPACITÉ MAXIMALE
Porta | Door | Porte
80 Kg

QR CODE





PORTA | Door | Porte
MADEIRA Carvalho Antiqua
 Wood | Bois Antiqua Oak | Chenê Antiqua

CONCHA | Flush | Vette
INOX Ref.: 1695 (16)
 Steel | Acier ● Satinado | Satin | Satiné

RETRO FOLD

O novo modelo RETRO FOLD é um sistema de porta de correr que se destaca pelo seu design marcadamente contemporâneo e a sua estrutura robusta, ideal para transformar qualquer ambiente, seja rústico ou moderno, trazendo um toque de carisma e sofisticação. Além da sua versatilidade, é uma verdadeira peça de destaque na decoração, garantindo um deslizamento suave das portas e um resultado final verdadeiramente vibrante e acolhedor. Fixação exclusiva na parede.

The new RETRO FOLD is a sliding door system that stands out for its distinct contemporary design and robust structure, ideal for transforming any environment, whether rustic or modern, bringing a touch of charisma and sophistication. In addition to its versatility, it is a real statement piece in any kind of decor, guaranteeing a smooth sliding and a truly vibrant and warm end result. For wall mounting only

Le nouveau modèle RETRO FOLD est un système de portes coulissantes qui se distingue par son design résolument contemporain et sa structure robuste, idéal pour transformer n'importe quel environnement, soit rustique, soit moderne, en y apportant une touche de charisme et de sophistication. En plus de sa polyvalence, c'est une véritable pièce maîtresse sur tout type de décor, en garantissant un coulissement en douceur et un résultat final vraiment vibrant et accueillant. Pour montage mural seulement.

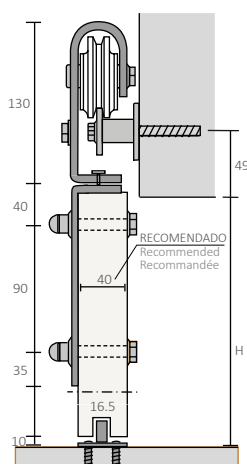
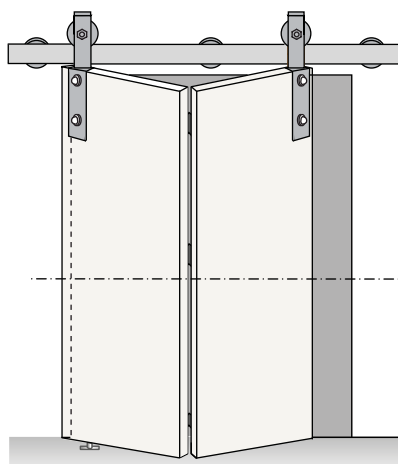

KIT 2 PORTAS 2 DOORS KIT KIT 2 PORTES	
2 x PORTA Door Porte	KIT KIT
500	1169
KIT 4 PORTAS 4 DOORS KIT KIT 4 PORTES	
4 x PORTA Door Porte	KIT KIT
450	2000
700	3000

REF: 11.0120.005

QR CODE



Cores | Cores | Couleurs



CAPACIDADE MÁXIMA
 MAXIMUM CAPACITY / CAPACITÉ MAXIMALE
Porta | Door | Porte
 80 Kg

Porta alveolar necessita reforço superior de 165 mm.
 Doors with honeycomb core require a reinforced top rail of 165 mm.
 Les portes à âme alvéolaires nécessitent une traverse supérieure renforcée de 165 mm.

ARTIGOS INCLUÍDOS | INCLUDED ITEMS | ARTICLES INCLUS:

KIT 2 PORTAS 2 DOORS KIT KIT 2 PORTES		KIT 4 PORTAS 4 DOORS KIT KIT 4 PORTES	
1x Barra de Aço Steel bar Barre d'acier	1x Kit acessórios Accessories Kit Kit d'accessoires	2x Barra de Aço Steel bar Barre d'acier	2x Kit acessórios Accessories Kit Kit d'accessoires



Madeira
 Wood | Bois
 35 | 40 | 45

H - Altura | Height | Hauteur
 HP - Altura da porta | Door height | Hauteur de la porte
 FH - Altura do painel fixo | Height fixed panel | Hauteur de panneau fixe

L - Largura | Width | Largeur
 LP - Largura da porta | Door width | Largeur de la porte
 P - Porta | Door | Porte
 PF - Painel Fixo | Fixed panel | Panneau fixe



PORTA | Door | Porte Mod. **1H-4FM**



MADEIRA
Wood | Bois

WENGUÉ RW
Wenge RW



INOX
Steel | Acier

Ref: IN 16.414 RAW
Industrial RAW

CONCHA | Flush | Vette

STYLE WOOD

Versátil e fácil de aplicar, o STYLE WOOD é composto por uma calha tubular de aço inoxidável de fixação à parede e por um sistema de roldanas de elevada qualidade para instalação de uma porta de correr em madeira.

The STYLE WOOD is a versatile solution that enables the installation of a wooden sliding door in a stainless steel tubular track fixed on the wall and with a high quality sliding system.

Le STYLE WOOD est une solution versatile qui permet l'installation d'une porte coulissante en bois à travers un rail en acier inoxydable fixé sur la paroi et d'un système de poulies de haute qualité.

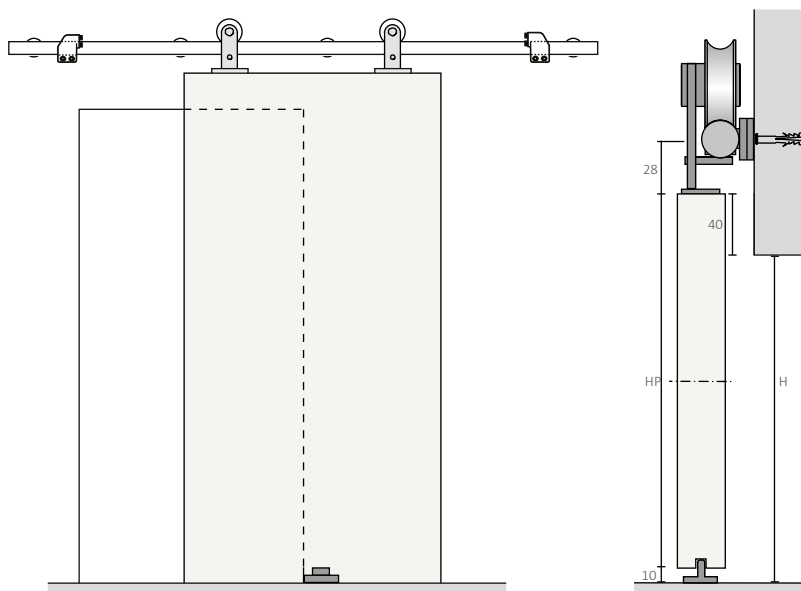

DIMENSÃO DIMENSION	
 PORTA Door Porte	 KIT KIT
600 - 1000	2000
1001 - 1500	3000

REF: 11.0104.004

ARTIGOS INCLUÍDOS | INCLUDED ITEMS | ARTICLES INCLUS:

1 PORTA | Door | Porte

1x Varão Inox 2000mm Ø25
Stainless steel track
Barre en inox

1x Kit acessórios
Accessories set
Kit d'accessoires

CAPACIDADE MÁXIMA
MAXIMUM CAPACITY / CAPACITÉ MAXIMALE

Porta | Door | Porte

60 Kg

QR CODE





PORTA | Door | Porte

 **VIDRO** **TRANSPARENTE**
Glass | Verre Clear | Transparent

ASA PARA PORTA | Pull Handle | Barre de tirage

INOX Ref.: IN.07.201.600
Steel | Acier ● Satinado | Satin | Satiné

STYLE GLASS

Elegante e moderno, este sistema permite a aplicação de uma porta de correr em vidro até 60kg, através da fixação à parede de uma calha tubular em aço e do recurso a um sistema de roldanas de elevada qualidade.

Stylish and modern, the STYLE GLASS allows the application of a glass sliding door up to 60kg in a wall mounted stainless steel tubular track and with a high quality rollers system.

Porta de vidro não comercializada
Glass door not available for sale
Porte en verre indisponible

Élégant et moderne, le STYLE GLASS permet l'application d'une porte coulissante en verre jusqu'à 60 kg par la fixation au mur d'un rail tubulaire en acier inoxydable et avec un système de poulies de haute qualité.

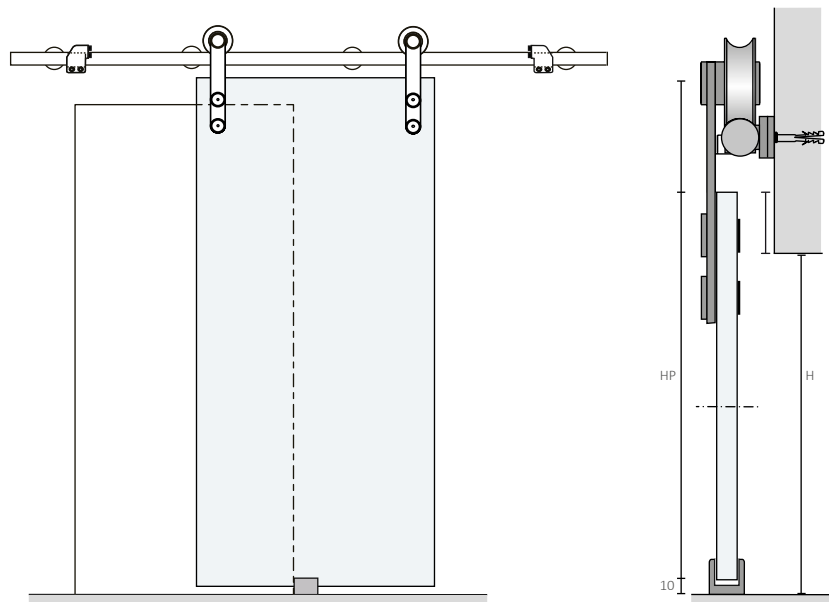

DIMENSÃO DIMENSION	
 PORTA Door Porte	 KIT KIT
600 - 1000	2000

REF: 11.0104.003

QR CODE



CAPACIDADE MÁXIMA
MAXIMUM CAPACITY / CAPACITÉ MAXIMALE
Porta | Door | Porte
60 Kg

ARTIGOS INCLUÍDOS | INCLUDED ITEMS | ARTICLES INCLUS:

1 PORTA | Door | Porte

1x Varão Inox 2000mm Ø25
Stainless steel track
Barre en inox

1x Kit acessórios
Accessories set
Kit d'accessoires



Vidro
Glass | Verre
8 | 10

Porta vidro com furação
Door glass with hole
Porte en verre avec trou

H - Altura | Height | Hauteur
HP - Altura da porta | Door height | Hauteur de la porte
FH - Altura do painel fixo | Height fixed panel | Hauteur de panneau fixe

L - Largura | Width | Largeur
LP - Largura da porta | Door width | Largeur de la porte
P - Porta | Door | Porte
PF - Painel Fixo | Fixed panel | Panneau fixe



PORTA | Door | Porte



RIPADO ACÚSTICO SLENDER

SLENDER Acoustic slat wall | Mural en Lattes acoustique SLENDER

PATENTED

INVISIBLE WOOD

Especialmente concebido para os clientes mais exigentes, o INVISIBLE WOOD permite a instalação de uma porta em madeira com um sistema de correr inovador completamente invisível. Sem elementos inestéticos visíveis, o INVISIBLE WOOD possibilita a criação de espaços modernos e sofisticados, nos quais as suas portas se tornam elementos decorativos essenciais.

Specially designed for the most demanding customers, the INVISIBLE WOOD enables the application of a sliding door with an innovative completely invisible sliding system. Without unaesthetic visible elements, the INVISIBLE WOOD enables the creation of sophisticated and modern spaces. This new OPENSOURCE system transforms any space into a modern design room, making the simplest doors a primary decorative element that can be customized to your taste.

Opcional | Optional | Option
EASY SOFT

L'INVISIBLE WOOD est une solution exclusive qui permet l'installation d'une porte coulissante avec un système coulissant innovant et complètement invisible. Sans éléments inesthétiques visibles, ce système transforme tous les pièces en espaces de design modernes et élégants, ce qui fait de vos portes des éléments décoratifs essentiels qui peuvent être totalement personnalisés.

KIT 1 PORTA | DOOR | PORTE

LARGURA MÁX. PORTA Max. door width Largueur max. de la porte	KIT KIT
1100	1100
1800	1800

DIMENSÃO PORTA

DOOR DIMENSION | DIMENSION PORTE

	OPÇÃO 1 OPTION 1	OPÇÃO 2 OPTION 1	OPÇÃO 3 OPTION 1
X	118	60	0
LP	L+100	L+158	L+218

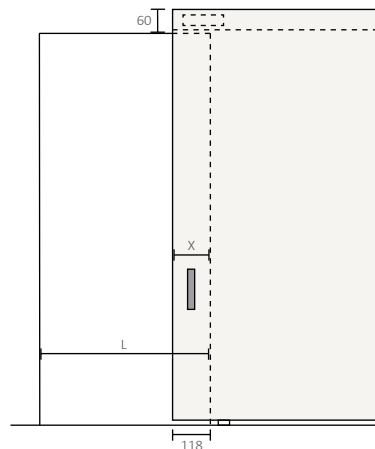
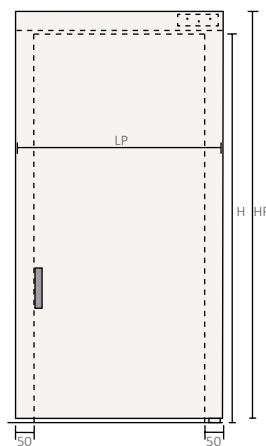
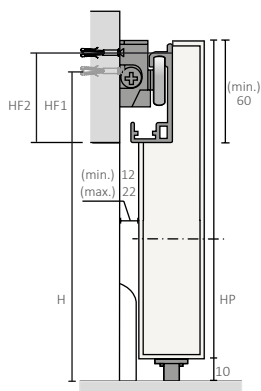
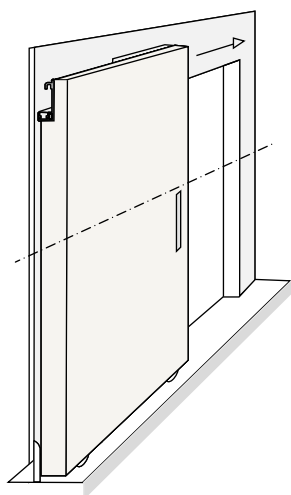

REF: 11.0116

QR CODE



CAPACIDADE MÁXIMA
MAXIMUM CAPACITY / CAPACITÉ MAXIMALE
Porta | Door | Porte
80 Kg

ARTIGOS INCLUÍDOS | INCLUDED ITEMS | ARTICLES INCLUS:

- 1x Calha em alumínio
Aluminium track
Rail en aluminium
- 1x Kit acessórios
Accessories set
Kit d'accessoires



Madeira
Wood | Bois
35|40|45



Largura da porta
Door width
Largueur de la porte

H - Altura | Height | Hauteur
HP - Altura da porta | Door height | Hauteur de la porte
FH - Altura do painel fixo | Height fixed panel | Hauteur de panneau fixe

L - Largura | Width | Largeur
LP - Largura da porta | Door width | Largeur de la porte
P - Porta | Door | Porte
PF - Painel Fixo | Fixed panel | Panneau fixe



PORTA | Door | Porte **ANKARA**



Madeira
Wood | Bois

LACADO | Lacquered | Laqué
Branco | White | Blanc



CONCHA | Flush | Vette

INOX
Steel | Acier

Ref.: 2639 (16)
● Satinado | Satin | Satiné

INSIDE

Este inovador sistema de embutir no teto permite a utilização de uma porta de correr em madeira e vidro de grandes dimensões. Sem elementos inestéticos visíveis, o INSIDE cria ambientes modernos, funcionais e sofisticados.

Exclusive for plasterboard walls, this innovative in-ceiling system allows the use of a large dimension wooden or glass sliding door.
Without unaesthetic visible elements, the INSIDE creates modern, functional and sophisticated rooms.

Exclusif pour des murs en plaques de plâtre, cet innovant système d'encastrement au faux-plafond permet l'utilisation d'une porte coulissante en bois ou en verre de grandes dimensions.
Sans éléments inesthétiques visibles, l'INSIDE crée des espaces plus modernes, fonctionnels et sophistiqués.

Opcional | Optional | Option
EASY SOFT INSIDE ◀■■■■▶

DIMENSÃO
DIMENSION



2000
3000
4000
6000

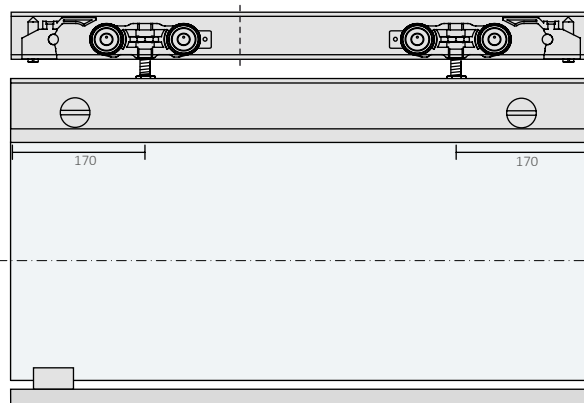
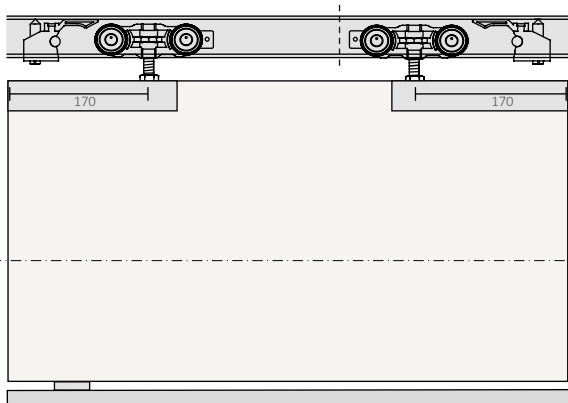

Porta de vidro não comercializada
Glass door not available for sale
Porte en verre indisponible

ARTIGOS NECESSÁRIOS REQUIRED ITEMS ARTICLES NÉCESSAIRES:			1 PORTA Door Porte	
CALHAS TRACKS RAILS	Madeira Wood Bois	Vidro Glass Verre		
6 R: 1013	Sem Soft Soft Without Sans Soft	1x 9007 9008 9009 Kit Inside wood Inside kit Kit Inside	1x 9005 Kit de acessórios Accessories kit Kit d'accessoires	1x 8002 Kit Pinça contínua Clamp Kit Kit Pince
6C R: 1030	Soft duplo Double Soft	1x 9016 9017 9018 Kit Inside wood Inside wood kit Kit Inside Wood	1x 9019 Kit Inside wood Inside Wood kit Kit Inside Wood	1x 8002 Kit Pinça contínua Clamp Kit Kit Pince
6D R: 1031				

EN1527 : 2013
- 6 3 - 1 0 - 1 3

CAPACIDADE MÁXIMA
MAXIMUM CAPACITY / CAPACITÉ MAXIMALE
Porta | Door | Porte
120 Kg

QR CODE



INSIDE - CALHA Nº6 | TRACK NR 6 | RAIL Nº6

EN1527 : 2013

- 6 3 - 1 0 - 1 3

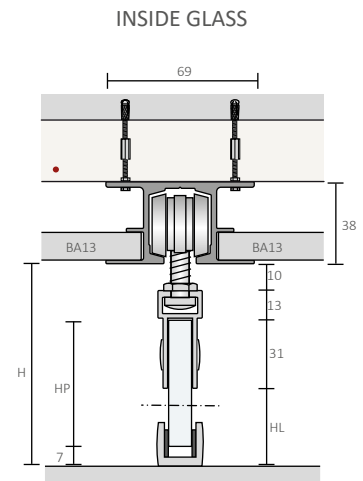
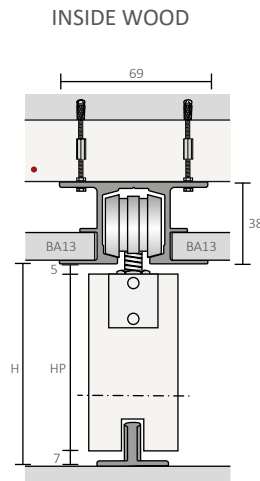
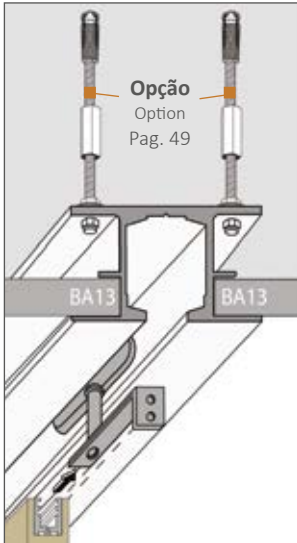

INSIDE - CALHA Nº6C | TRACK NR 6C | RAIL Nº6C

EN1527 : 2013

- 6 3 - 1 0 - 1 3

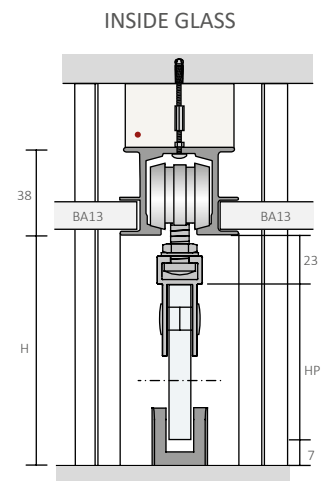
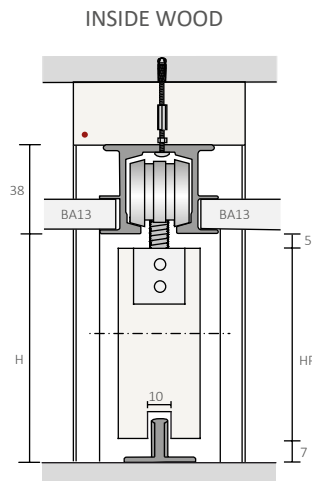
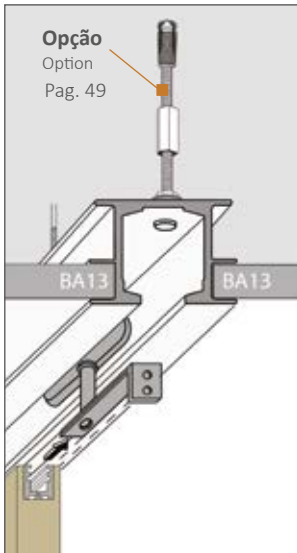

INSIDE - CALHA Nº6D | TRACK NR 6D | RAIL Nº6D

EN1527 : 2013

- 6 3 - 1 0 - 1 3

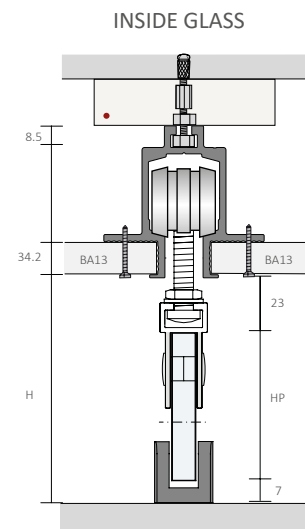
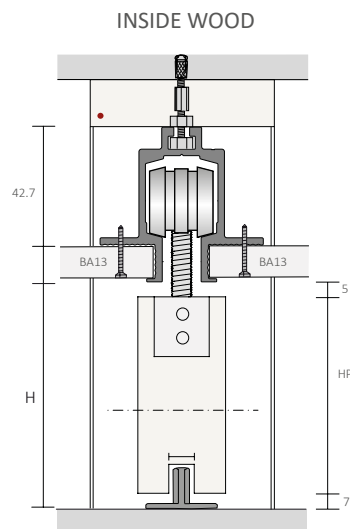
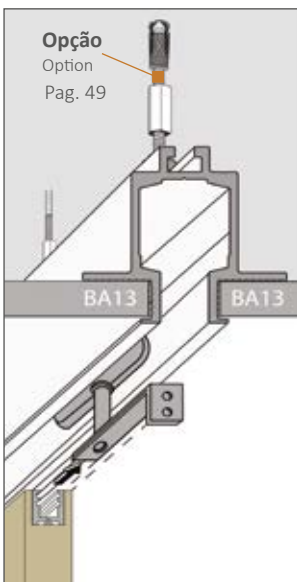

• Viga em madeira para reduzir vibrações no teto falso (não fornecido)
Wooden beam to reduce the false ceiling vibrations (not supplied)
Poutre en bois pour réduire les vibrations du faux plafond (Non fourni)

H - Altura | Height | Hauteur
HP - Altura da porta | Door height | Hauteur de la porte
FH - Altura do painel fixo | Height fixed panel | Hauteur de panneau fixe

L - Largura | Width | Largeur
LP - Largura da porta | Door width | Largeur de la porte
P - Porta | Door | Porte
PF - Painel Fixo | Fixed panel | Panneau fixe



PORTA | Door | Porte



VIDRO
Glass | Verre



Fosco
Frosted | Dépoli

ASA PARA PORTA | Pull Handle | Barre de tirage

INOX
Steel | Acier

Ref: IN.07.201.1200

● **Satinado** | Satin | Satiné

INSIDE DV

Desenvolvido especialmente para embutir no teto falso, o INSIDE DV possibilita a instalação de uma porta de correr e de um painel fixo em vidro, criando uma separação elegante entre dois espaços distintos.

Composto por uma calha em alumínio de fixação ao teto falso, o INSIDE DV apresenta-se como um sistema discreto que comunica com os espaços contíguos, mantendo a harmonia das linhas arquitetônicas.

The in-ceiling INSIDE DV system was specially designed for the installation of a glass sliding door with a fixed panel, creating an elegant separation between two distinct spaces.

Composed by an in-ceiling aluminium track, the INSIDE DV presents itself as a discrete system which communicates with the adjacent spaces while maintaining the harmony of the architectural lines.

Porta de vidro não comercializada
Glass door not available for sale
Porte en verre indisponible

Opcional | Optional | Option
EASY SOFT INSIDE ◀◀◀◀◀◀▶▶▶▶▶▶▶▶

DIMENSÃO
DIMENSION



2000
3000
4000
6000

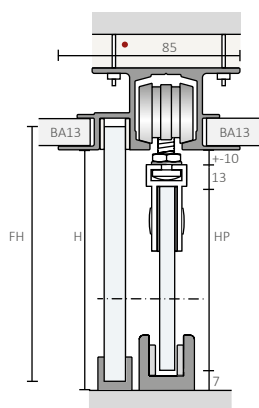

Exemplo de aplicação
Application example | Exemple d'application:

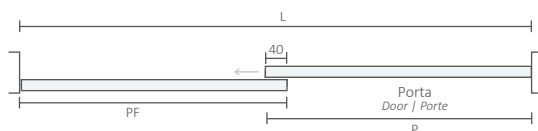

ARTIGOS NECESSÁRIOS REQUIRED ITEMS ARTICLES NÉCESSAIRES:			1 PORTA Door Porte
CALHAS TRACKS RAILS	Vidro Glass Verre		
7	R: 1014 Sem Soft Soft Without Sans Soft	1x 9005 Kit de acessórios Accessories kit Kit d'accessoires	1x 8002 Kit Pinça contínua Clamp Kit Kit Pince
	R: 1021 Soft duplo Double Soft	1x 9019 Kit Inside wood Inside Wood kit Kit Inside Wood	

EN1527 : 2013

- 6 3 - 1 0 - 1 3

CAPACIDADE MÁXIMA

MAXIMUM CAPACITY / CAPACITÉ MAXIMALE

Porta | Door | Porte

120 Kg

QR CODE





PORTA | Door | Porte **DUO**



VIDRO **TRANSPARENTE**
Glass | Verre Clear | Transparent



Alumínio **LACADO** | Lacquered | Laqué
Aluminium Preto | Black | Noir

ASA PARA PORTA | Pull Handle | Barre de tirage

INOX
Steel | Acier

Ref: IN.07.200.D.25.TB
○ Titânio preto | Black titan | Titan noir

INSIDE DUO

Ideal para criar ambientes exclusivos, o INSIDE DUO é composto por um inovador sistema de calha dupla de embutir no teto que permite a utilização de portas de correr de grandes dimensões.

Moderno e elegante, este sistema assume-se como a solução ideal para criar espaços de design, estando disponível para portas de madeira ou vidro com moldura em alumínio.

Ideal for creating exclusive environments, the INSIDE DUO consists of an innovative in-ceiling dual rail system that allows the use of large sliding doors.

Modern and stylish, this system assumes itself as the ideal solution to create design spaces, allowing the use of wooden or aluminium framed glass doors.

Idéal pour créer des environnements exclusifs, l'INSIDE DUO se compose d'un système innovant de double rail au plafond qui permet l'utilisation de grandes portes coulissantes.

Moderne et élégant, ce système s'assume comme la solution idéale pour créer des espaces de design et permet l'utilisation de portes en bois ou en verre encadrées avec un profil en aluminium.

Opcional | Optional | Option
EASY SOFT INSIDE ◀■■■■■▶

DIMENSÃO
DIMENSION



2000

3000

4000

6000

Exemplos de aplicação
Application examples | Exemples d'application:

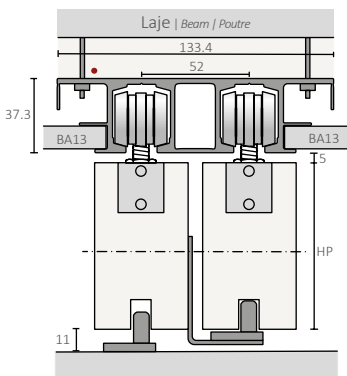
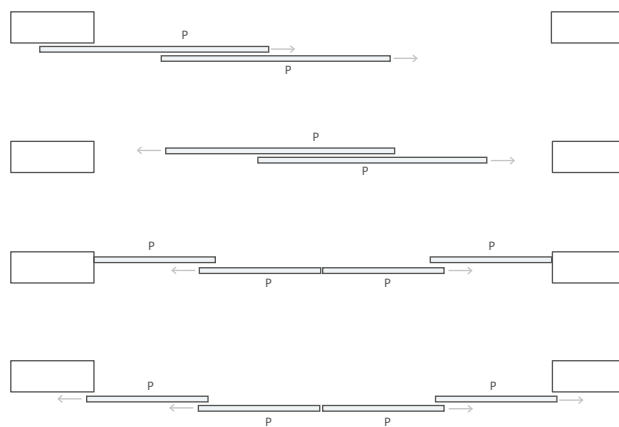

Porta de madeira
Wooden door | Porte en bois

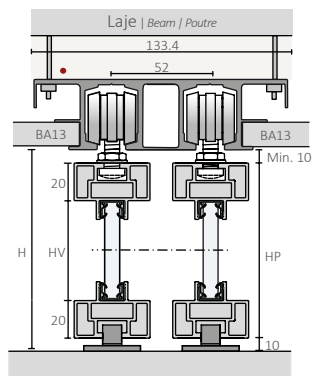

Porta de vidro com moldura em alumínio
Dimensão máxima 1200x2600mm

Aluminium framed glass door | Maximum dimension 1200x2600mm
Porte en verre avec un cadre en aluminium | Dimension maximale 1200x2600mm



EN1527 : 2013
- 6 3 - 1 0 - 1 3
CAPACIDADE MÁXIMA MAXIMUM CAPACITY / CAPACITÉ MAXIMALE
Porta Door Porte
120 Kg

ARTIGOS NECESSÁRIOS REQUIRED ITEMS ARTICLES NÉCESSAIRES:			2 PORTAS Doors Portes		
CALHAS TRACKS RAILS	Madeira Wood Bois	1x 7017	2x 9005 Kit de acessórios	3x 7004	
		Guia inferior	Kit d'accessoires	Guia inferior	
12 R: 1015	Sem Soft Soft Without Sans Soft	2x 9007 9008 9009	Floor guide Guide inférieure	Kit d'accessoires	Guia inferior
	Soft duplo Double Soft	2x 9016 9017 9018	Floor guide Guide inférieure	9019 Kit de acessórios	Guia inferior
		1x 7007 + 7013	Floor guide Guide inférieure	Kit d'accessoires	Guia inferior



Madeira
Wood | Bois
35 | 40 | 45



Vidro
Glass | Verre
8 | 10

Porta vidro com furação
Door glass with hole
Porte en verre avec trou

H - Altura | Height | Hauteur
HP - Altura da porta | Door height | Hauteur de la porte
FH - Altura do painel fixo | Height fixed panel | Hauteur de panneau fixe

L - Largura | Width | Largeur
LP - Largura da porta | Door width | Largeur de la porte
P - Porta | Door | Porte
PF - Painel Fixo | Fixed panel | Panneau fixe



PORTA | Door | Porte



VIDRO
Glass | Verre



Fosco
Frosted | Dépoli

ASA PARA PORTA | Pull Handle | Barre de tirage

INOX
Steel | Acier

Ref: IN.07.201.1200
● Satinado | Satin | Satiné

DIVISION

Requintado e funcional, o DIVISION apresenta-se como uma solução eficaz para a divisão de espaços de grandes dimensões. Com um sistema de calhas embutidas no teto, o DIVISION possibilita a conjugação de painéis fixos e portas de correr em vidro (até quatro folhas), ficando o sistema oculto por uma elegante aba em alumínio.

Stylish and functional, DIVISION is an effective solution for dividing large spaces. With a ceiling mounted rail system, DIVISION allows the combination of fixed panels and glass sliding doors (up to four panels), whose system is hidden with an elegant aluminium cover.

Porta de vidro não comercializada
Glass door not available for sale
Porte en verre indisponible

Opcional | Optional | Option
EASY SOFT INSIDE ◀■■■■■▶

Élégant et fonctionnel, le DIVISION se présente comme une solution effective pour séparer les grands espaces.

Avec un système de rails au plafond, le DIVISION permet la combinaison de panneaux fixes et des portes coulissantes en verre (jusqu'à quatre vantaux), dont les systèmes sont cachés avec des élégants bandeaux en aluminium.

DIMENSÃO	
DIMENSION DIMENSION	
	2000
	3000
	4000
	6000

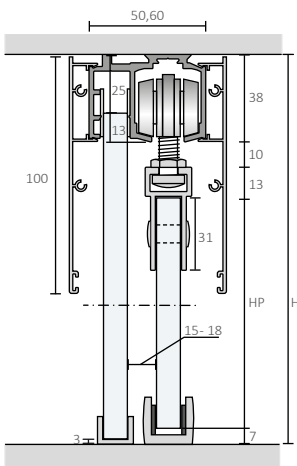

Exemplos de aplicação
Application examples | Exemples d'application:

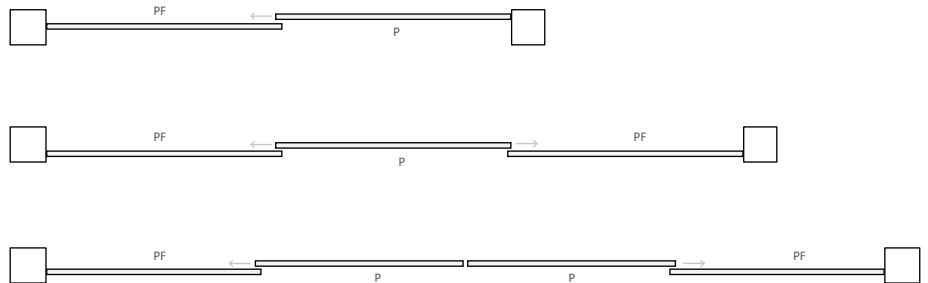

ARTIGOS NECESSÁRIOS REQUIRED ITEMS ARTICLES NÉCESSAIRES:			
CALHAS TRACKS RAILS		Vidro Glass Verre 1PORTA Door Porte	
9	R: 1004	Sem Soft Soft Without Sans Soft	1x 9005 Kit de acessórios Accessories kit Kit d'accessoires
	R: 1021	Soft duplo Double Soft	1x 9019 Kit Inside wood Inside Wood kit Kit Inside Wood
			1x 8002 Kit Pinça contínua Clamp Kit Kit Pince
			2x Aba Nº2 Cover nr. 2 Bandeau nº2

EN1527 : 2013
- 6 3 - 1 0 - 1 3
CAPACIDADE MÁXIMA MAXIMUM CAPACITY / CAPACITÉ MAXIMALE
Porta Door Porte
120 Kg





PORTA | Door | Porte



VIDRO
Glass | Verre

TRANSPARENTE
Clear | Transparent

ASA PARA PORTA | Pull Handle | Barre de tirage

INOX
Steel | Acier

Ref: IN.07.201.600

● Satinado | Satin | Satiné

INSIDE DUO GLASS

Com a calha dupla de embutir no teto, este sistema de correr exclusivo para vidro permite a instalação de portas até ao teto e a separação de espaços de forma simples e eficaz.

Versátil, moderno e sofisticado, o INSIDE DUO GLASS foi pensada para os clientes que valorizam o design e a funcionalidade.

With an in-ceiling double rail, this glass exclusive sliding system allows the installation of ceiling height doors and the separation of spaces in a simple and effective way.

Versatile, modern and sophisticated, the INSIDE DUO GLASS was specially designed for customers who value design and functionality.

Porta de vidro não comercializada
Glass door not available for sale
Porte en verre indisponible

Opcional | Optional | Option
EASY SOFT INSIDE ◀◀◀◀◀◀◀◀

DIMENSÃO
DIMENSION



KIT
KIT

2000

3000

4000

6000

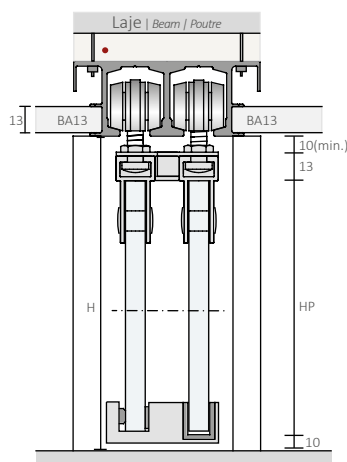

Exemplos de aplicação:
Application examples | Exemples d'application

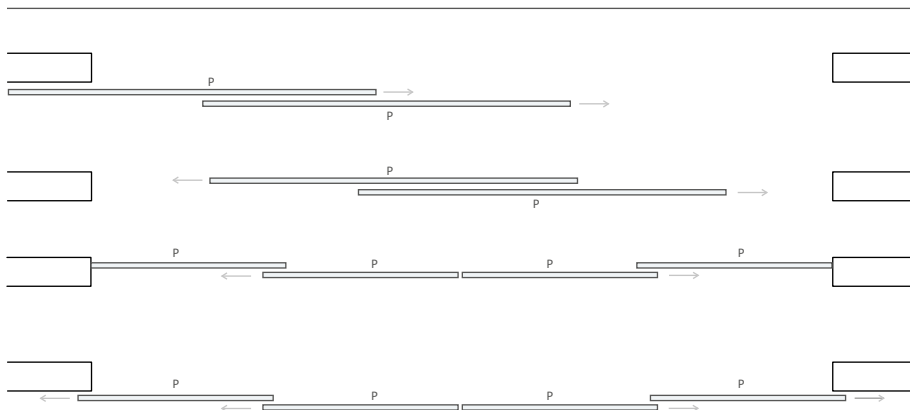

QR CODE



EN1527 : 2013

- 6 3 - 1 0 - 1 3

CAPACIDADE MÁXIMA
MAXIMUM CAPACITY / CAPACITÉ MAXIMALE
Porta | Door | Porte

120 Kg

ARTIGOS NECESSÁRIOS | REQUIRED ITEMS | ARTICLES NÉCESSAIRES:

CALHAS TRACKS RAILS		Vidro Glass Verre		2 PORTAS Doors Portes
13	R: 1016	Sem Soft Soft Without Sans Soft	2x 9005 Kit de acessórios Accessories kit Kit d'accessoires	2x 8002 Kit Pinça contínua Clamp Kit Kit Pince
		Soft duplo Double Soft	2x 9019 Kit Inside wood Inside Wood kit Kit Inside Wood	1x 7012 Kit de acessórios Accessories kit Kit d'accessoires



Largura do kit
Kit width
Largueur du kit



Largura da porta
Door width
Largueur de la porte



Vidro
Glass | Verre
8 | 10

Porta vidro com furação
Door glass with hole
Porte en verre avec trou

H - Altura | Height | Hauteur

HP - Altura da porta | Door height | Hauteur de la porte

FH - Altura do painel fixo | Height fixed panel | Hauteur de panneau fixe

L - Largura | Width | Largeur

LP - Largura da porta | Door width | Largeur de la porte

P - Porta | Door | Porte

PF - Painel Fixo | Fixed panel | Panneau fixe



PORTA | Door | Porte



VIDRO
Glass | Verre

TRANSPARENTE
Clear | Transparent

ASA PARA PORTA | Pull Handle | Barre de tirage

INOX
Steel | Acier

Ref: IN.07.201.600

● Satinado | Satin | Satiné

TELESCOPIC GLASS

Criado a pensar nos espaços mais exigentes, o novo TELESCOPIC GLASS permite a conjugação de um painel fixo com duas portas de correr paralelas em vidro. O TELESCOPIC GLASS é uma solução exclusiva para vidro que permite uma separação elegante de espaços e que alia as vantagens de um modelo de fixação ao teto com a funcionalidade de um sistema de duas portas paralelas.

Created for the most challenging spaces, the new TELESCOPIC GLASS enables the combination of a fixed glass panel with two sliding parallel glass doors. The TELESCOPIC GLASS is a unique solution for glass that allows an elegant separation of spaces which combines the advantages of a ceiling mounted solution with the functionality of two parallel doors system.

Porta de vidro não comercializada
Glass door not available for sale
Porte en verre indisponible

Opcional | Optional | Option
EASY SOFT INSIDE ◀◀◀◀◀◀◀◀

DIMENSÃO
DIMENSION



2000

3000

4000

6000

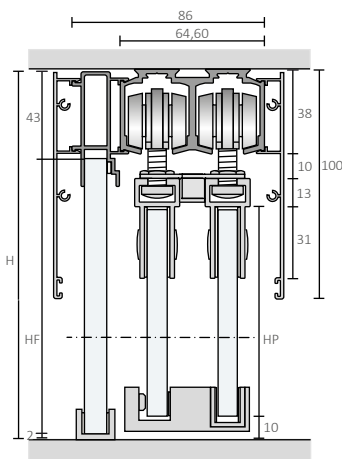

Exemplos de aplicação:
Application examples | Exemples d'application

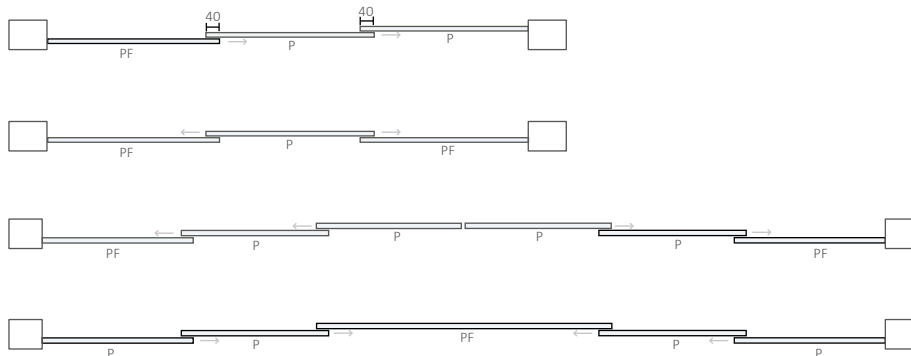

ARTIGOS NECESSÁRIOS | REQUIRED ITEMS | ARTICLES NÉCESSAIRES:

CALHAS TRACKS RAILS	Vidro Glass Verre			2 PORTAS Doors Portes
11	R: 1006 Sem Soft Soft Without Sans Soft	2x 9005 Kit de acessórios Accessories kit Kit d'accessoires	2x 8002 Kit Pinça contínua Clamp Kit Kit Pince	2x Aba Nº2 Cover nr. 2 Bandeau n°2
	R: 1017 Soft duplo Double-Soft	2x 9019 Kit Inside wood Inside Wood kit Kit Inside Wood	1x 7012 Kit de acessórios Accessories kit Kit d'accessoires	
	R: 1021			

EN1527 : 2013
- 6 3 - 1 0 - 1 3

CAPACIDADE MÁXIMA
MAXIMUM CAPACITY / CAPACITÉ MAXIMALE
Porta | Door | Porte
120 Kg





PORTA | Door | Porte

Mod. 2V



Madeira
Wood | Bois

PINHO | Pine | Pin
HARVEST OAK | Harvest Oak



CONCHA | Flush | Vette

INOX
Steel | Acier

Ref: 4128 (141)
● **Titânio** | Titan

WOOD

Pensado para estilos requintados, o sistema WOOD apresenta-se como o casamento perfeito entre design e natureza.

Composto por uma aba e uma prumada batente em madeira, esta solução de fixação à parede permite a aplicação de uma porta de correr em madeira com o sistema de correr elegantemente oculto.

Conceived for exquisite styles, the WOOD system presents itself as the perfect marriage between design and nature.

Composed by a wooden track cover and a strike post, this wall mounted solution enables the application of a wooden sliding door, with the sliding system elegantly hidden.

Pensé pour les styles exquis, le système WOOD se présente comme le mariage parfait entre le design et la noblesse du bois.

Composé par bandeau et un arrêt battant en bois, cette solution de fixation murale permet l'utilisation d'une porte en bois et la dissimulation élégante du système.

DIMENSÃO DIMENSION	
<p>PORTA Door Porte</p>	<p>KIT KIT</p>
600- 1000	2100

Cores de Portas e Aros | Consulte catálogo Nº2 PORTAS
Door and Door frame colours | Check Door catalogue Nº2
Couleurs des portes et Huissiers | Consultez catalogue Nº2 Portes

Versão A | Version A | Version A

- Com prumada batente | With strike post | Avec arrêt battant

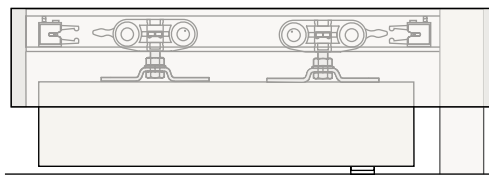
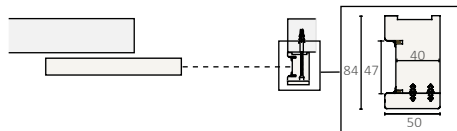

Versão B | Version B | Version B

- Sem prumada batente | Without strike post | Sans arrêt battant

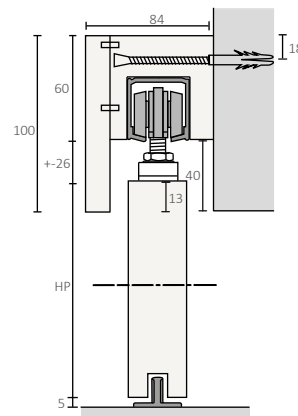
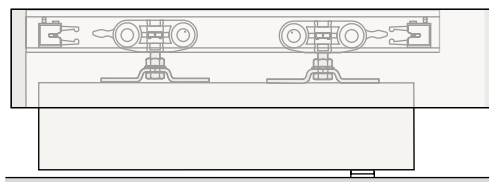
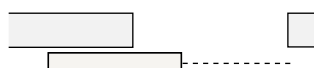

REF: 11.0113

Disponível em vários acabamentos | Available in several finishing options | Disponible en divers finitions

ARTIGOS INCLUÍDOS | INCLUDED ITEMS | ARTICLES INCLUS:

1 PORTA | Door | Porte

1x 1001 | Calha 8A em alumínio
Aluminium track 8A
Rail en aluminium 8A

1x Aba em madeira
Wooden track covers
Bandeaux cache-rails bois

1x 9003 | Kit acessórios
Accessories Kit
Kit d'accessoires

1x Prumada batente
Strike post
Arrêt battant

EN1527 : 2013

- 6 2 - 1 0 - 1 3

CAPACIDADE MÁXIMA

MAXIMUM CAPACITY / CAPACITÉ MAXIMALE

Porta | Door | Porte

80 Kg

QR CODE





PORTA | Door | Porte



MADEIRA
Wood | Bois

Harvest Oak
Harvest Oak



CONCHA | Flush | Vette

INOX
Steel | Acier

Ref.: 1695

(153)

● Preto pérola | Black Pearl | Noir Pearl

HARMÓNIO

Inovador e prático, o HARMÓNIO foi pensado para a divisão de grandes espaços, onde o design e a funcionalidade são elementos essenciais.



Composto um sistema de calhas de embutir no tecto e no chão, o HARMÓNIO permite a utilização de duas ou quatro portas com abertura em livro, criando ambiente modernos, estéticos e funcionais.

Innovative and practical, the HARMONIO was designed for dividing large spaces, where design and functionality are key elements.

Composed by a system of aluminum tracks embedded in the ceiling and floor, the HARMONIO enables the use of two or four bi-folding doors, creating modern, aesthetic and functional environments.

Innovant et pratique, l'HARMONIO a été conçu pour diviser les grands espaces où le design et la fonctionnalité sont essentiels.

Composé par un système de rails d'encastrer dans le plafond et au sol, l'HARMONIO permet l'utilisation de deux ou quatre portes repliables, créant un environnement moderne, esthétique et fonctionnel.

DIMENSÃO DIMENSION DIMENSION	
PORTA Door Porte	
	2600 Max.
	2000
	+/- 800 Max.
	3000
	4000
	6000

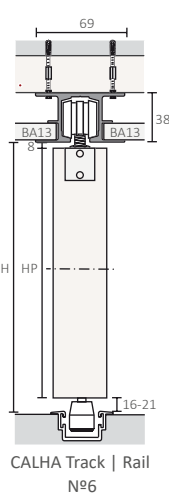
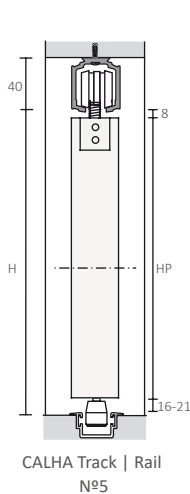
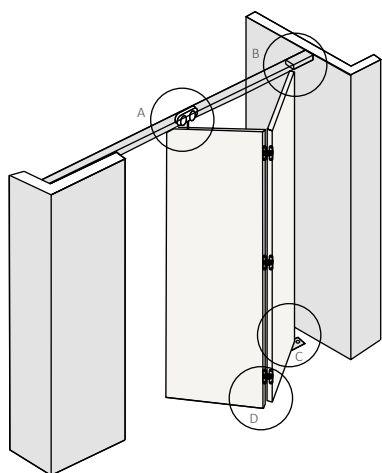

Exemplo com duas portas
Example for double doors | Exemple avec deux portes

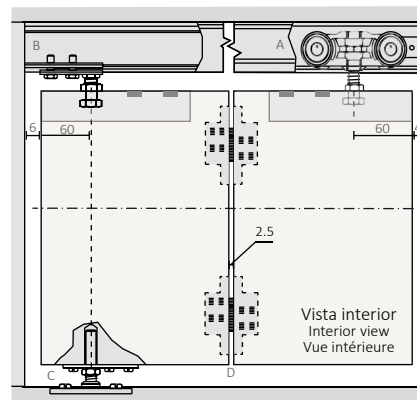

QR CODE



EN1527 : 2013

- 6 3 - 1 0 - 1 3

CAPACIDADE MÁXIMA
MAXIMUM CAPACITY / CAPACITÉ MAXIMALE

Porta | Door | Porte

40 Kg

ARTIGOS NECESSÁRIOS | REQUIRED ITEMS | ARTICLES NÉCESSAIRES:

CALHA Track Rail	2 PORTAS Doors Portes	4 PORTAS Doors Portes	6 PORTAS Doors Portes
5 REF: 1038	 120 Kg	9023 Kit 2 Portas 2 Doors Kit Kit 2 portes	9024 Kit 4 Portas 4 Doors Kit Kit 4 portes
6 REF: 1040			
6C REF: 1037			



Largura do kit
Kit width
Largeur du kit



Madeira
Wood | Bois
35 | 40 | 45

H - Altura | Height | Hauteur
HP - Altura da porta | Door height | Hauteur de la porte
FH - Altura do painel fixo | Height fixed panel | Hauteur de panneau fixe

L - Largura | Width | Largeur
LP - Largura da porta | Door width | Largeur de la porte
P - Porta | Door | Porte
PF - Painel Fixo | Fixed panel | Panneau fixe

CALHAS PARA PORTAS DE CORRER | TRACKS FOR SLIDING DOORS | RAILS POUR PORTES COULISSANTES

1001 | Calha nº 8A
Track nr 8A | Rail nº 8A

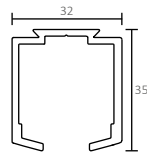

AB

2000 | 3000
4000 | 6000
6830

↔

Kg
80

1002 | Calha nº 8B
Track nr 8B | Rail nº 8B

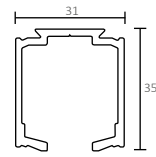

AN

2000 | 3000
4000 | 6000

↔

Kg
80

Opcional: Aba em alumínio
Optional: Aluminium cover
Optionnel: Bandeau en aluminium

1033 | Calha nº 8C
Track nr 8C | Rail nº 8C

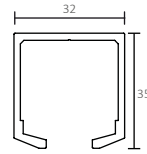

AB

6000 | 6830

↔

Kg
80

1003 | Calha nº 5
Track nr 5 | Rail nº 5

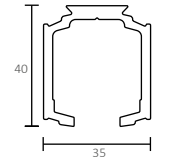

AN

2000 | 3000
4000 | 6000

↔

Kg
120

Opcional: Aba em alumínio
Optional: Aluminium cover
Optionnel: Bandeau en aluminium

1004 | Calha nº 9
Track nr 9 | Rail nº 9

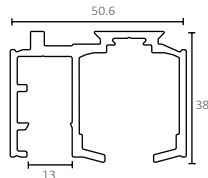

AN

2000 | 3000
4000 | 6000

↔

Kg
120

Opcional: Aba em alumínio
Optional: Aluminium cover
Optionnel: Bandeau en aluminium

1005 | Calha dupla nº 10
Double track nr 10 | Rail double nº 10

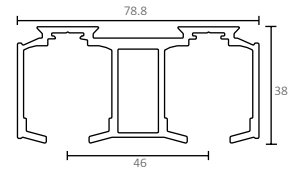

AN

2000 | 3000
4000 | 6000

↔

Kg
120

Opcional: Aba em alumínio
Optional: Aluminium cover
Optionnel: Bandeau en aluminium

1006 | Calha dupla nº 11
Double track nr 11 | Rail double nº 11

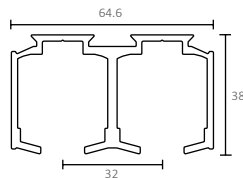

AN

2000 | 3000
4000 | 6000

↔

Kg
120

Opcional: Aba em alumínio
Optional: Aluminium cover
Optionnel: Bandeau en aluminium

1007 | Calha easy clip
Track easy clip | Rail easy clip

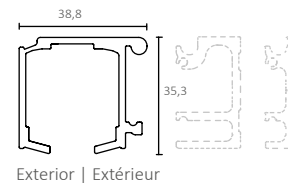

AN

2000 | 3000
4000 | 6000

↔

Kg
120

Exterior | Extérieur

Aplicação | Application

Ref: 1008 Ref: 1009

1008 | Calha easy clip A - Madeira
Wood - Track easy clip A | Rail easy clip A - Bois

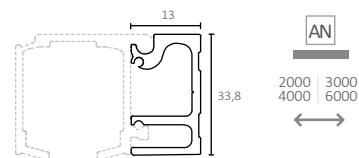

AN

2000 | 3000
4000 | 6000

↔

Kg
120

Interior | Intérieur

1009 | Calha easy clip B - Vidro
Glass - Track easy clip B | Rail easy clip B - Verre

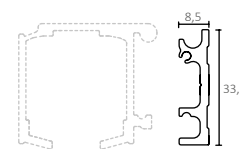

AN

2000 | 3000
4000 | 6000

↔

Kg
120

Interior | Intérieur

1010 | Calha Slide
Track slide | Rail slide



AP
AN

2000 | 3000
4000 | 6000

↔

Kg
120

Exterior | Extérieur

1011 | Calha Slide - Madeira
Wood - Track slide | Rail slide - Bois

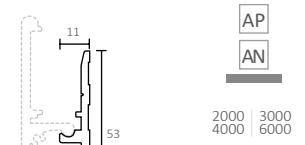

AP
AN

2000 | 3000
4000 | 6000

↔

Kg
120

Interior - Intérieur

CALHAS PARA TETO FALSO | FALSE CEILING TRACKS | RAILS POUR FAUX PLAFOND

1013 | Calha nº 6

Track nr 6 | Rail nº 6

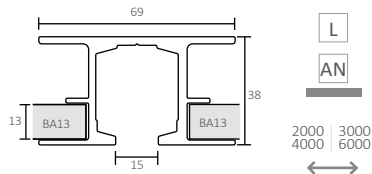

2000 3000
4000 6000



Para teto em gesso cartonado
For plasterboard ceilings
Pour plafonds en plaques de plâtre

ENCONTRO
ENCONTRO | ENCONTRO
REF. 1023

HARMÓNIO
Harmonia | Harmonia
REF. 1040

1030 | Calha nº 6C

Track nr 6C | Rail nº 6C

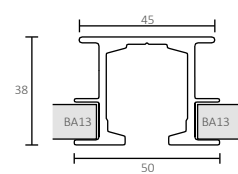

2000 3000
4000 6000



Para teto em gesso cartonado
For plasterboard ceilings
Pour plafonds en plaques de plâtre

UNICO PLUS
UNICO PLUS | UNICO PLUS
Ref.: 1030

HARMÓNIO
Harmonia | Harmonia
Ref.: 1037

1031 | Calha nº 6D

Track nr 6D | Rail nº 6D

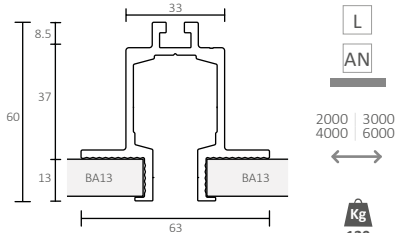

2000 3000
4000 6000



Para teto em gesso cartonado
For plasterboard ceilings
Pour plafonds en plaques de plâtre

1014 | Calha nº 7

Track nr 7 | Rail nº 7

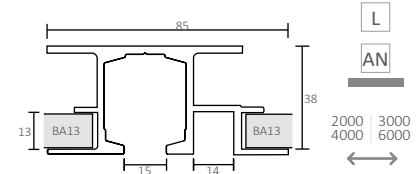

2000 3000
4000 6000



Para teto em gesso cartonado
For plasterboard ceilings
Pour plafonds en plaques de plâtre

1015 | Calha dupla nº 12

Double track nr 12 | Rail double nº 12

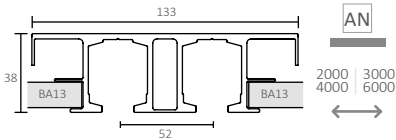

2000 3000
4000 6000



Para teto em gesso cartonado
For plasterboard ceilings
Pour plafonds en plaques de plâtre

1016 | Calha dupla nº 13

Double track nr 13 | Rail double nº 13

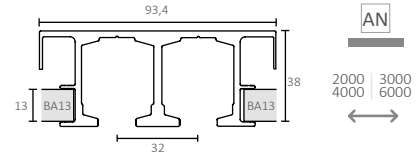

2000 3000
4000 6000



Para teto em gesso cartonado
For plasterboard ceilings
Pour plafonds en plaques de plâtre

1017 | Calha para painel fixo

Fixed panel track | Rail pour panneau fixe

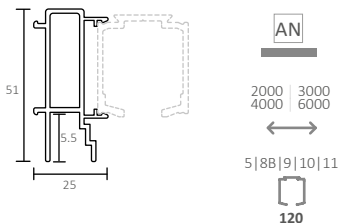

2000 3000
4000 6000



Kit de acessórios de fixação

Fixing accessories Kit | Kit accessoires de fixation

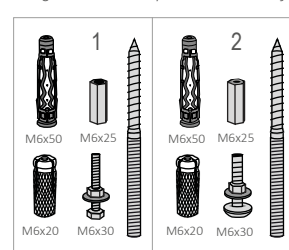

	REFERÊNCIA REFERENCE REFERENCE	CALHA Nº TRACK NR. RAIL Nº	DIMENSÃO DIMENSION DIMENSION
1	11.0315.001	6 6D 7 12 13	2000
	11.0315.002	6 6D 7 12 13	3000
	11.0315.003	6 6D 7 12 13	4000
	11.0315.004	6 6D 7 12 13	6000
2	11.0315.005	6C	2000
	11.0315.006	6C	3000
	11.0315.007	6C	4000
	11.0315.008	6C	6000

ABAS PARA PORTAS DE CORRER | TRACK COVERS | BANDEAUX CACHE-RAILS

Aba nº 2

Cover nr 2 | Bandeau nº 2

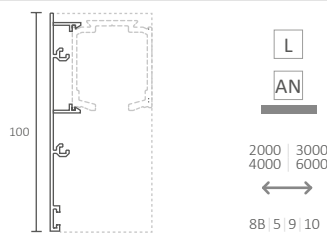

2000 3000
4000 6000



Para portas de vidro com pinça contínua aplicadas em calhas de fixação ao teto.
For glass doors with Continuous clamps applied in ceiling mounted tracks.
Pour portes en verre avec la pince continue installées en rails de fixations au plafond.

Aba nº 5

Cover nr 5 | Bandeau nº 5

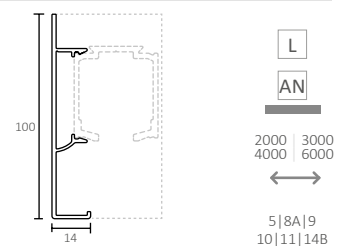

2000 3000
4000 6000



Para porta de vidro aplicada em calhas de fixação à parede.
For glass doors applied in wall mounted tracks.
Pour portes en verre installées en rails de fixation au mur.

Aba nº 6

Cover nr 6 | Bandeau nº 6

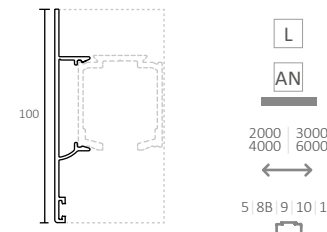

2000 3000
4000 6000



Para portas de madeira ou vidro aplicadas em calhas de fixação à parede.
For wooden or glass doors applied in wall mounted tracks.
Pour portes en bois ou en verre installées en rails de fixation au mur.

Aba nº 7

Cover nr 7 | Bandeau nº 7

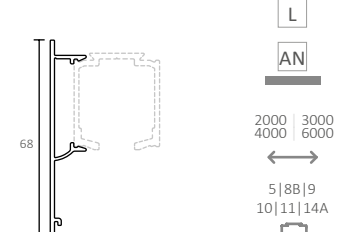

2000 3000
4000 6000



Para portas de madeira aplicadas em calhas de fixação à parede ou teto.
For wooden doors applied in wall mounted or ceiling mounted tracks.
Pour portes en bois installées en rails de fixation à mur au plafond.

TAMPAS laterais para abas | SIDE COVERS | COUVERCLES LATÉRALES



REFERÊNCIA REFERENCE RÉFÉRENCE	LADO SIDE CÔTE	DIMENSÃO DIMENSION DIMENSION	ABAS COVERS BANDEAUX	CALHA TRACK RAIL	SISTEMA SYSTEM SYSTÈME
13001	Rev.	45,5x102	Nº5	Nº8B	Elegance Glass
13002	Rev.	57,5x102	Nº2	Nº8B	Elegance Wood
13003	Rev.	68x102		Nº 9	Division
13004	Rev.	85x102		Nº 11	
13005	Rev.	108x102		Nº 10	
13007	Esq./Dir.	52x105	Nº5	Nº 14B	Elegance Glass
13008	Rev.	33x51		Nº 6D	Inside
13009	Esq./Dir.	64x73	Nº7	Nº 14A	Elegance Wood

Esq. | Esquerdo / Left / Gauche Dir. | Direita/Right/Droite Rev. | Reversível / Reversible/Réversible

KIT DE ACESSÓRIOS PARA PORTAS DE CORRER | SLIDING DOORS ACCESSORIES KIT | KIT D'ACCESSOIRES POUR PORTES COULISSANTES

9003 | Kit de acessórios 80 kg
80 kg accessories kit | Kit d'accessoires 80 kg



9004 | Kit de acessórios 120 kg
120 kg accessories kit | Kit d'accessoires 120 kg



9005 | Kit de acessórios 120 kg
120 kg accessories kit | Kit d'accessoires 120 kg



Necessita de kit pinça contínua (ver pag. 52)
Requires the purchase of a continuous clamping kit (see page 52)
Necessite de l'achat d'un kit de pince continue (voir page 52)

Kit de acessórios INSIDE WOOD
INSIDE WOOD accessories kit | Kit d'accessoires INSIDE WOOD

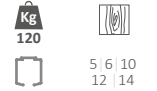

REFERÊNCIA REFERENCE RÉFÉRENCE	↔	LARG. PORTA DOOR WIDTH LARGEUR PORTE
9007	190 mm	< 1200mm
9008	260 mm	≥ 1200 mm
9009	360 mm	≥ 1600 mm

Kit de acessórios INSIDE WOOD SOFT
INSIDE WOOD with soft accessories kit | Kit d'accessoires INSIDE WOOD avec soft



REFERÊNCIA REFERENCE RÉFÉRENCE	↔	LARG. PORTA DOOR WIDTH LARGEUR PORTE	SOFT Kg
9016	190	< 1200mm	80
9017	260	≥ 1200 mm	100
9018	360	≥ 1600 mm	100

9019 | Kit de acessórios INSIDE GLASS soft
INSIDE GLASS with soft accessories kit | Kit d'accessoires INSIDE GLASS avec soft



10002 | Kit acessórios caixilhos OPENSACE
OPENSACE pocket frame accessories kit | Kit d'accessoires caissons OPENSACE



Modelo | Model | Modèle
Unico
Encontro
Paralelo
Inverso



10003 | Kit acessórios caixilhos XL
Pocket frames XL accessories kit | Kit d'accessoires caissons XL



Kit de acessórios caixilho PLUS
PLUS pocket frames accessories kit | Kit d'accessoires caissons PLUS



REFERÊNCIA REFERENCE RÉFÉRENCE	↔	LARG. PORTA DOOR WIDTH LARGEUR PORTE	PLUS SOFT REFERÊNCIA REFERENCE RÉFÉRENCE
10004	190 mm	< 1200 mm	10005
10012	260 mm	≥ 1200 mm	10008
10013	360 mm	≥ 1600 mm	10009

Kit de acessórios caixilho XL soft
XL soft pocket frames accessories kit | Kit d'accessoires caissons XL soft



REFERÊNCIA REFERENCE RÉFÉRENCE	SOFT Kg
10010	80
10011	100

KIT HARMÓNIO | KIT HARMÓNIO

9023 | Kit Harmónio para 2 portas
Bi folding doors kit | Kit Harmonio pour deux portes



9024 | Kit Harmónio para 4 portas
Harmonio kit for four doors | Kit Harmonio pour quatre portes



É necessário a instalação do perfil inferior 20x15. (Pag. 54)
Requires the application of a 20x15 inferior profile. (Pag. 54)
Il est nécessaire l'installation d'un profil inférieur 20x15. (Pag. 54)

9025 | Kit Harmónio para 6 portas
Harmonio kit for six doors | Kit Harmonio pour six portes



É necessário a instalação do perfil inferior 20x15. (Pag. 54)
Requires the application of a 20x15 inferior profile. (Pag. 54)
Il est nécessaire l'installation d'un profil inférieur 20x15. (Pag. 54)

5 6 6C



kg
40

KIT PARALELO | KIT PARALELO

7008 | Kit para portas paralelas em madeira
Parallel wooden door kit | Kit pour portes parallèles en bois



Instalação na porta. Necessita de rasgo inferior na porta.
To install in the door. Door inferior groove is required.
Installation dans la porte. Rainure inférieure de la porte nécessaire.

Aplicação:
Caixilho PARALELO WOOD
Application:
PARALELO WOOD pocket frame
Application:
Caisson PARALELO WOOD

Espessura de porta
Door thickness
Épaisseur de porte
Min. 35mm

10 12



7012 | Kit para portas paralelas em vidro
Parallel glass doors kit | Kit pour portes parallèles en verre



Aplicação em pinça contínua (Pag. 52)
Application on continuous clamping (Pag.52)
Application dans le pince continue (Pag.52)

Aplicação:
Porta de vidro
Caixilho PARALELO GLASS

Application:
Glass doors
PARALELO GLASS pocket frame

Application:
Portes en verre
Caisson PARALELO GLASS

Espessura do vidro
Glass thickness
Épaisseur de verre
8 10 mm

11 13



TRAVÃO AMORTECEDOR EASY SOFT | EASY SOFT DAMPER STOP | FREIN AMORTISSEUR EASY SOFT

TIPOS DE TRAVÃO AMORTECEDOR
Damper stop types | Types de frein amortisseur

	MODELO MODEL MODÈLE	EASY SOFT	EASY SOFT INSIDE
CAIXILHOS POCKET FRAMES CONTRE-CHÂSSIS	UNICO	X	-
	UNICO XL	-	X
	UNICO PLUS	-	X
	UNIKIT	-	-
	ENCONTRO	X	-
	ENCONTRO XL	-	X
	PARALELO WOOD	X	-
	PARALELO GLASS	-	X
	PARALELO WOOD PLUS	-	X
	PARALELO GLASS PLUS	-	X
INVERSO	X	-	
INVERSO WOOD PLUS	-	X	
EASY KITS	STANDARD WOOD 120 Kg	-	X
	ELEGANCE WOOD 120 Kg	-	X
	ELEGANCE GLASS	-	X
	RETRO SLIM MAXI	X	-
	RETRO FOLD	-	-
	STYLE WOOD GLASS	-	-
	INSIDE	-	X
	INSIDE DV	-	X
	INSIDE DUO	-	X
	INSIDE DUO GLASS	-	X
	DIVISION	-	X
	TELESCOPIC GLASS	-	X
	TELESCOPIC TRIPLE GLASS	-	X
	SLIDE WOOD	X	-
	INVISIBLE WOOD	X	-
	WOOD	-	-
	HARMÓNIO	-	-

Travão amortecedor Easy Soft
Easy soft damper stop | Frein amortisseur Easy Soft

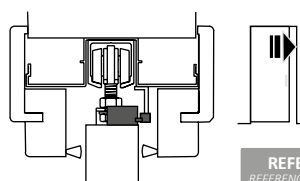

Aplicação:
Porta de correr em madeira

Application:
Sliding wooden doors

Application:
Porte coulissante en bois



REFERÊNCIA REFERENCE RÉFÉRENCE	KG KG	PORTA DOOR PORTE	MODELOS MODEL MODÈLE
4006	40		UNICO ENCONTRO
4008	80		UNIKIT PARALELO WOOD
4009	100		INVERSO WOOD
4010	80		Porta de vidro Glass door
4011	100		Porte en verre

Travão Easy soft Inside 80 | 100 | 120Kg
Easy Soft Inside damper stop | Frein amortisseur Easy Soft Inside

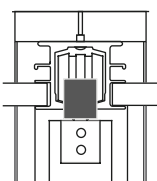

Aplicação:
Porta de correr
Madeira | Vidro

Application:
Wooden | Glass
Sliding doors

Application:
Porte coulissante
Bois | Verre



REFERÊNCIA REFERENCE RÉFÉRENCE	LARGURA MIN. PORTA DOOR MIN. WIDTH LARGEUR MIN. PORTE	SOFT Kg
4014	≥ 750 <1100	80
4015	≥ 1200	100

REFERÊNCIA REFERENCE RÉFÉRENCE	LARGURA MIN. PORTA DOOR MIN. WIDTH LARGEUR MIN. PORTE	SOFT Kg
4017	≥ 800	80
4018	≥ 800	100
4019	≥ 800	120

KIT DE UNIÃO | UNION KIT | KIT D'UNION

Kit de união para caixilho ENCONTRO

ENCONTRO pocket frame union kit | Kit d'union pour le caisson ENCONTRO

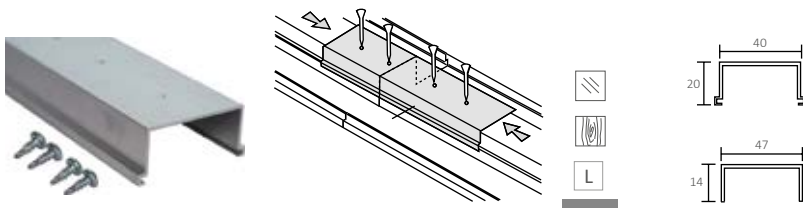

Perfil em alumínio que permite unir dois caixilhos UNICO ou UNIKIT para criar um caixilho ENCONTRO

Aluminium profile that allows to connect two UNICO or UNIKIT pocket frames to create an ENCONTRO pocket frame.

Profil en aluminium qui permet l'union de deux caissons UNICO ou UNIKIT pour la création d'un caisson ENCONTRO.

REFERÊNCIA REFERENCE / RÉFÉRENCE	CAIXILHO UNICO POCKET FRAME / CAISSON	ACABAMENTO FINISHING / FINITION
10007	Gesso cartonado Plasterboard Plaques de plâtre	Alumínio Aluminium
10006	Alvenaria Mortar Enduit	Chapa zincada Galvanised sheet Tôle galvanisé

KITS PARA PORTA DE CORRER EM VIDRO | GLASS SLIDING DOOR KITS | KITS POUR PORTES COULISSANTES EN VERRE

8002 | Kit de pinça contínua

Continuous clamping kit | Kit de pince continue

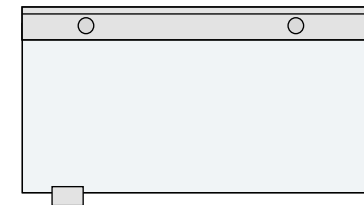
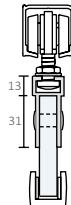

Espessura do vidro
Glass thickness
Épaisseur de verre
8 | 10 mm



799 | 899 | 1099
1299 | 1499 mm



120 Kg

8003 | Kit de pinças redondas para Porta de vidro

Glass door round clamping kit | Portes en verre kit des pinces rondes



50 Kg

Necessita de furação do vidro. Aplicação de vidro temperado de 8 | 10mm
Requires glass drilling. For use with 8 | 10mm tempered glass.
Necessite de la perçage du verre. Pour installé avec verre trempé de 8 | 10 mm.

8004 | Kit de pinças redondas para fenólico

Round clamping kit for phenolic doors | Kit des pinces rondes pour portes phénoliques



Aplicação:
Porta em fenólico de 12 mm

To use with:
12 mm phenolic doors

Application:
Portes phénoliques de 12 mm



50 Kg

ABERTURA SIMULTÂNEA | SIMULTANEOUS OPENING | OUVERTURE SIMULTANÉE

Kit Syncro ENCONTRO | ENCONTRO syncro kit | Kit Syncro ENCONTRO



Modelos
Modèles | modèles
Encontro
Encontro XL

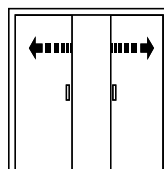

Kit Syncro PARALELO | PARALELO syncro kit | Kit Syncro PARALELO



Modelos
Modèles | modèles
PARALELO
PARALELO XL

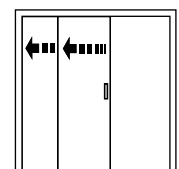

REFERÊNCIA REFERENCE / RÉFÉRENCE	APLICAÇÃO APPLICATION
2001	Portas de madeira Wooden doors Portes en bois
2002	Porta de vidro Glass doors Portes en verre

REFERÊNCIA REFERENCE / RÉFÉRENCE	APLICAÇÃO APPLICATION
2003	Portas de madeira Wooden doors Portes en bois
2004	Porta de vidro Glass doors Portes en verre

RODÍZIOS | TROLLEYS | CHARIOT

3003 | Rodízio 80 kg

80 kg trolley | Chariot 80 kg



Aplicação:
Porta de correr

Application:
Sliding door

Application:
Porte Coulissante

8A | 8B | 8C



3005 | Rodízio 120 kg

120 kg trolley | Chariot 120 kg



Aplicação:
Porta de correr

Application:
Sliding door

Application:
Porte Coulissante

5 | 6 | 7 | 9 | 10
11 | 12 | 13 | 14



TRAVÃO | STOP | FREINS

4012 | Travão 80 kg

80 kg Stop | Frein 80 kg



Aplicação:
Porta de correr

Application:
Sliding door

Application:
Porte Coulissante



4005 | Travão 120 kg

120kg Stop | Frein 120kg



Aplicação:
Porta de correr

Application:
Sliding door

Application:
Porte Coulissante



GUIA INFERIOR PARA PORTA DE CORRER | FLOOR GUIDE FOR SLIDING DOORS | GUIDE INFÉRIEUR POUR PORTES COULISSANTES

7002 | Guia inferior ajustável
Adjustable floor guide | Guide inférieur ajustable

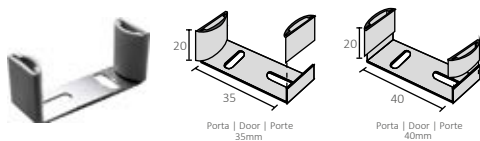

Aplicação:
Porta de correr
To use with:
Sliding doors
Application:
Porte coulissante

Espeçura de porta
Door thickness
Epaisseur de porte
Min. 35mm



Instalação no pavimento. Não necessita de rasgo inferior na porta.
To install on the flooring. Door inferior groove not required.
Installation au sols. Rainure inférieure de la porte n'est pas nécessaire.



7017 | Guia inferior
Floor guide | Guide inférieur



Aplicação:
Porta de correr
To use with:
Sliding doors
Application:
Porte coulissante

Espeçura de porta
Door thickness
Epaisseur de porte
Min. 35mm



Instalação no pavimento. Necessita de rasgo inferior na porta.
Floor installation. Door inferior groove is required.
Installation au sols. Rainure inférieure de la porte nécessaire.



7004 | Guia inferior rotativa Ø10
Ø10 Rotating floor guide | Guide inférieur rotative Ø10



Aplicação:
Porta de correr
To use with:
Sliding doors
Application:
Porte coulissante

Espeçura de porta
Door thickness
Epaisseur de porte
Min. 35mm



Instalação no pavimento. Necessita de rasgo inferior na porta.
To install on the flooring. Door inferior groove is required.
Installation au sols. Rainure inférieure de la porte nécessaire.



7006 | Guia inferior rotativa Ø16
Ø16 rotating floor guide | Guide inférieur rotative Ø16



Aplicação:
Harmónio de quatro portas
To use with:
4 doors HARMONIO
Application:
HARMONIO avec quatre portes

Espeçura de porta
Door thickness
Epaisseur de porte
Min. 35mm



Fixação na porta. Aplicar com o perfil Inferior 1018.
To install in the door. Use with the inferior profile nr 1018.
Fixation dans la porte. Installé avec le profil inférieur 1018.



7007 | Guia inferior para porta paralela
Floor guide for parallel doors | Guide inférieur pour portes parallèles

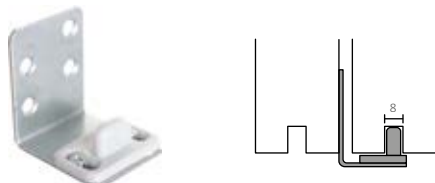

Aplicação:
Porta de correr
Caixilho Paralelo
To use with:
Wooden sliding doors
PARALELO pocket frame
Application:
Porte coulissante en bois
Caisson PARALELO



Instalação na porta. Necessita de rasgo inferior na porta.
To install in the door. Door inferior groove is required.
Installation dans la porte. Rainure inférieure de la porte nécessaire.

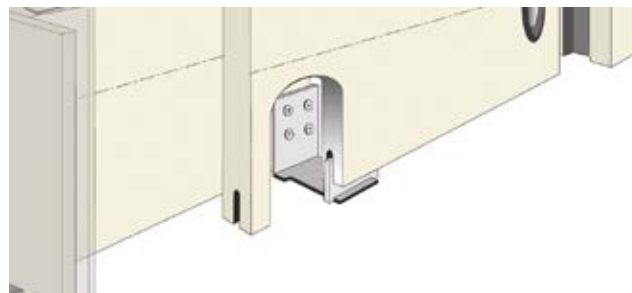

GUIA INFERIOR PARA PORTA DE VIDRO | GLASS DOORS FLOOR GUIDES | GUIDES INFÉRIEURS POUR PORTES EN VERRE

7009 | Guia inferior ajustável
Adjustable floor guide | Guide inférieur ajustable

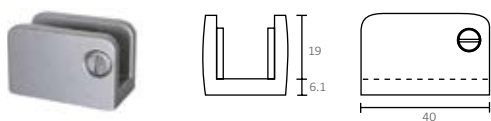

Aplicação:
Porta de vidro
8|10 mm
To use with:
8|10 mm
Glass doors
Applications:
Portes en verre
8|10 mm



7011 | Guia inferior para porta paralela
Parallel door floor guide kit | Kit guide inférieur pour portes parallèles

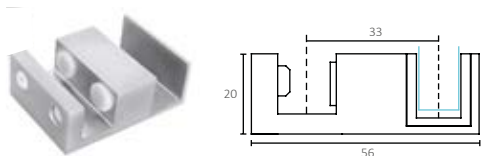

Aplicação:
Porta de vidro
8|10 mm
To use with:
8|10 mm
Glass doors
Applications:
Portes en verre
8|10 mm



7010 | Guia inferior ajustável
Adjustable floor guide | Guide inférieur ajustable

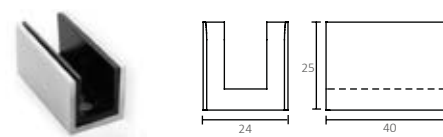

Aplicação:
Porta de vidro
8|10 | 12 mm
To use with:
8|10 | 12 mm
Glass doors
Applications:
Portes en verre
8|10 | 12 mm



BATENTES | BUFFERS | BUTTÉS

12002 | Batente para porta
Door buffer | Butté pour de porte



Aplicação:
Porta de correr
To use with:
Sliding doors
Application:
Porte coulissante

Para todos os caixilhos com porta de madeira
For all frames with wooden door
Pour tous les contre-châssis avec porte en bois

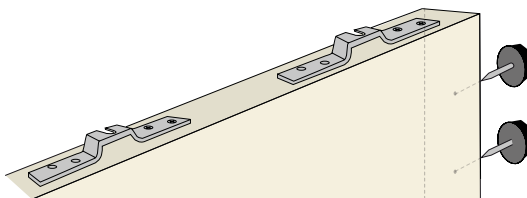

PERFIL INFERIOR | INFERIOR PROFILES | PROFILS INFÉRIEURS

7014 | Perfil inferior em PVC
PVC inferior profile | Profil inférieur en PVC

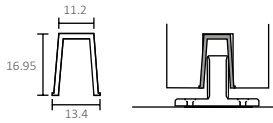

Para aplicação da guia inferior 7017
To use with the floor guide nr 7017
Pour l'utilisation avec la guide inférieure 7017

Espessura de porta mínimo 35mm
Min. 35mm Door thickness
Épaisseur de porte 35mm

Aplicação:
Porta de correr

Application:
Sliding door

Application:
Porte Coulissante



2500

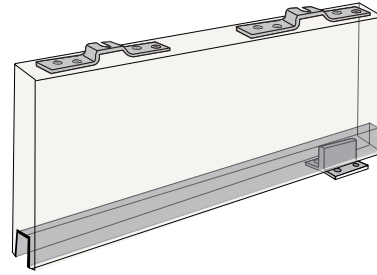

1018 | Perfil inferior 20x15
20x15 bottom track | Rail inférieur 20x15

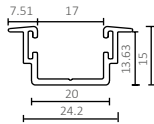

Para embutir no pavimento. Não inclui pelúcia.
To embed in the flooring. Pile seal not included.
Pour encastrer au sols. Joint brosse non inclus.

Opcional:
SP | Pelúcia 6,9x7

Optional:
SP | Pile seal 6,9x7

Optionnel:
SP | Joint brosse 6,9x7



2000 | 3000
4000 | 6000



1021 | Perfil inferior U 15x15
15x15 U bottom track | Rail inférieur U 15x15

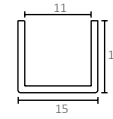

Para painel de vidro fixo de 8|10 mm.
For a 8|10 mm fixed glass panel.
Pour des panneaux fixes en verre de 8|10 mm.



1000
2000 | 3000
4000 | 6000



7013 | Perfil inferior de embutir na porta
Door embedded inferior profile | Profil inférieur d'encastrer dans la porte

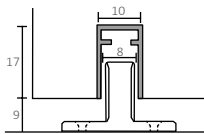

Para aplicação das guias inferiores 7017 e 7007
To use with the floor guide nr 7017 or nr 7007
Pour l'utilisation avec des guides inférieurs 7017 or 7007

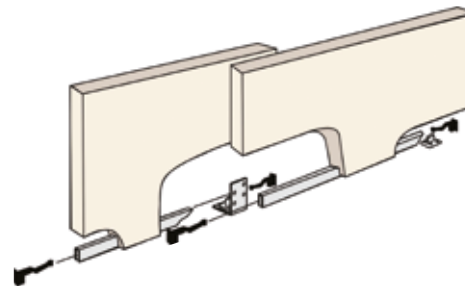

Aplicação:
Caixilho
PARALELO PLUS

Application:
PARALELO PLUS
Pocket frame

Application:
Caisson
PARALELO PLUS



3000

12



ARTIGOS NECESSÁRIOS | REQUIRED ITEMS | ARTICLES NÉCESSAIRES:

7016 | Perfil de topo
Edge profile | Profil d'arrêt



SUPORTES PARA PORTAS DE CORRER EM MADEIRA | WOODEN DOOR SLIDING BRACKETS | SUPPORTS POUR PORTES COULISSANTE EN BOIS

5001 | Suporte metálico
Metallic standard bracket | Support métallique standard

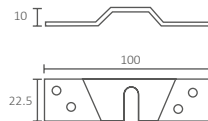

Espessura mínima da porta: 23 mm
Door minimum thickness: 23 mm
Épaisseur minimale de la porte: 23 mm

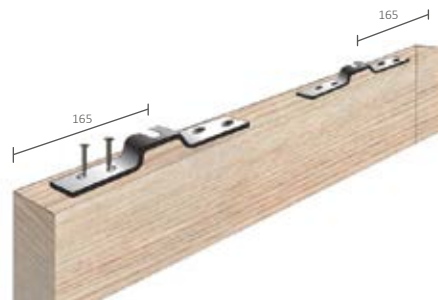

Aplicação:
Porta de correr

Application:
Sliding door

Application:
Porte Coulissante



Z

Suporte de embutir
Door embedding bracket | Supports d'encastrer



Espessura mínima da porta: 35 mm
Door minimum thickness: 35 mm
Épaisseur minimale de la porte: 35 mm

REFERÊNCIA REFERENCE RÉFÉRENCE	COMPRIMENTO LENGTH LONGUEUR	LARG. PORTA DOOR WIDTH LARGEUR PORTE
5002	190 mm	< 1200 mm
5003	260 mm	≥ 1200 mm
5004	360 mm	≥ 1600 mm

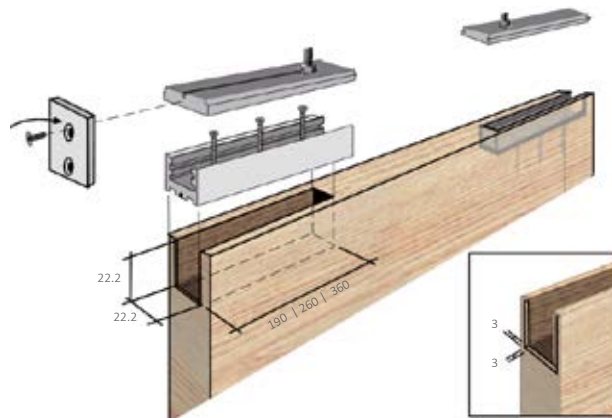

Aplicação:
Porta de correr

Application:
Sliding door

Application:
Porte Coulissante



Z

SUPORTES PARA CALHA DE CORRER | TRACK BRACKETS | SUPPORTS POUR LES RAILS

6003 | Suporte ajustável 50 mm

50 mm adjustable track bracket | Support ajustable 50 mm

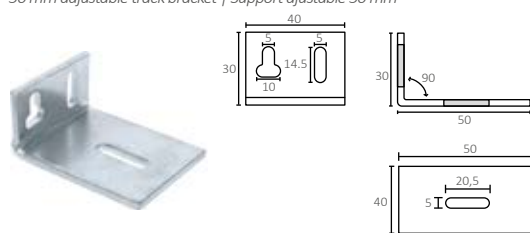

Aplicação:
Porta de correr

To use with:
Sliding doors

Application:
Porte coulissante

50x40x30



6004 | Suporte ajustável 30 mm

30 mm adjustable track bracket | Support ajustable 30 mm

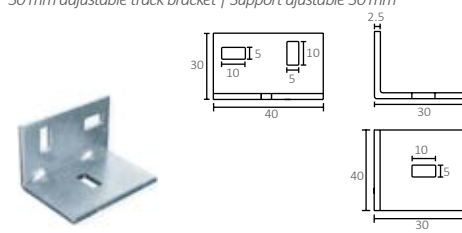

Aplicação:
Porta de correr

To use with:
Sliding doors

Application:
Porte coulissante

30x40x30



6005 | Suporte ajustável 95 mm

95 mm adjustable track bracket | Support ajustable 95 mm

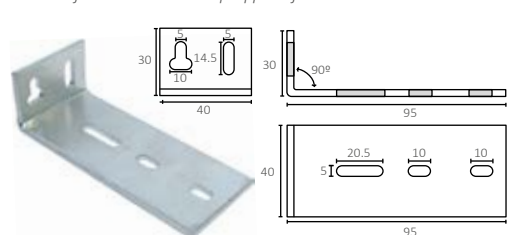

Aplicação:
Porta de correr

To use with:
Sliding doors

Application:
Porte coulissante

95x30x40



6006 | Suporte ajustável 70 mm

70 mm adjustable track bracket | Support ajustable 70 mm

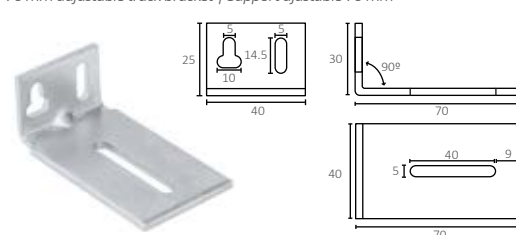

Aplicação:
Porta de correr

To use with:
Sliding doors

Application:
Porte coulissante

70x40x20

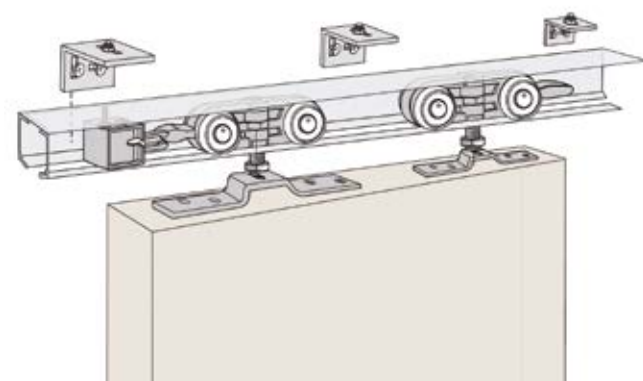

PELÚCIAS | PILE SEALS | JOINTS BROSSES

JM2 | Pelúcia | Pile seal | Joint brosse

Pelúcia para aro em madeira para porta de correr

Altura do pêlo: 9 | 12 | 16 mm
Cor: Branco | Preto | Bege | Castanho | Cinza

Pile seals for wooden frames

Pile height: 9 | 12 | 16 mm
Color: White | Black | Beige | Brown | Grey

Joint brosse anti-poussière pour huisserie en bois

Hauteur du brosse: 9 | 12 | 16 mm
Couleur: Blanc | Noir | Beige | Marron | Gris

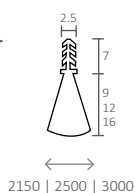

SP | Pelúcia 6,9x7 | Pile seal 6,9x7 | Joint brosse 6,9x7

Pelúcia para aro em alumínio e perfis diversos

Color: Branco | Cinza

Pile seal for aluminium frames and furniture

Color: White | Grey

Joint brosse anti-poussière pour huisserie en aluminium et meubles

Couleur: Blanc | Gris



225 m

Rolo | Roll | Rolle

BORRACHAS | RUBBER SEALS | JOINTS BUTÉES

MOD. A

Borracha ajustável para porta de vidro

Espessura do vidro: 8 | 10 mm

Adjustable rubber seal for glass door

Glass thickness: 8 | 10 mm

Joint butée ajustable pour porte en verre

Épaisseur du verre: 8 | 10 mm

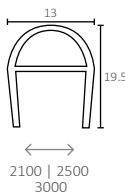
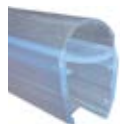

MOD. C

Borracha adesiva para porta de vidro

Espessura do vidro: 8 | 10 mm

Adhesive rubber seal for glass door

Glass thickness: 8 | 10 mm

Joint butée adhésif pour portes en verre

Épaisseur du verre: 8 | 10 mm

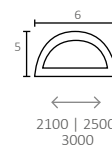

MOD. B

Borracha ajustável com aba de 12 mm para porta de vidro

Espessura do vidro: 8 | 10 mm

Adjustable rubber seal with a 12 mm flap for glass door

Glass thickness: 8 | 10 mm

Joint butée ajustable avec un onglet de 12 mm pour porte en verre

Épaisseur du verre: 8 | 10 mm

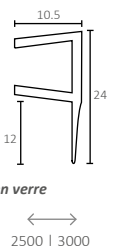
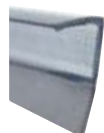

PERFIL DE UNIÃO

Perfil de união para madeira

Cor: Castanho claro

Connector profile

Wood connection on rubber strip

Color: Light brown

Joint butée de connection du bois

Couleur: Marron clair

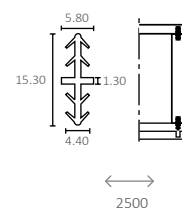

ARO EM CONTRAPLACADO PARA PORTA DE CORRER | PLYWOOD FRAME FOR SLIDING DOOR
HUISSERIE EN CONTREPLAQUÉ POUR PORTE COULISSANTE

MODELO UNICO
UNICO MODEL | MODÈLE UNICO

Kit composto por:

- Aro Contraplacado 25 | 30 mm
- Guarnição em WPC
- Pelúcia JM2 6mm
- Vedante acústico em borracha 552

Frame kit includes:

- 25 | 30 mm plywood jambs
- WPC architraves
- Pile JM2 6mm
- Rubber acoustic seal 552

Kit composé par:

- Huisserie contreplaqué 25 | 30 mm d'épaisseur
- Chambranles en WPC
- Joints brosses JM2 6mm
- Joint acoustique en caoutchouc 552

L	Max. 2000	H	Max. 2700
E	96 116 136 156 176 *		



Porta de madeira | Wooden door | Porte en bois

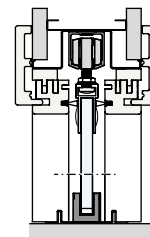
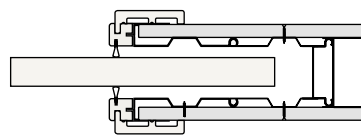
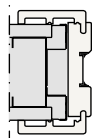

Porta de vidro | Glass door | Porte en verre

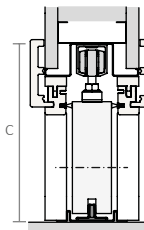
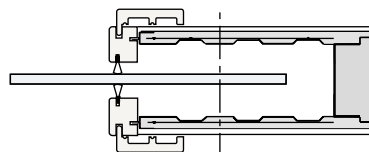
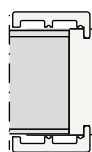

Nos caixilho com porta de correr em vidro, a altura livre é menor 60 mm que a altura standard.

*In pocket frames with glass doors, the clear height has 60 mm less than those with wooden doors.
La passage libre des caissons avec des portes en verre perd 60 mm d'haute en relation aux caissons avec des portes en bois.*

ARO WPC PARA PORTA DE CORRER | WPC HINGED DOOR FRAME | HUISSERIE WPC POUR PORTE BATTANTE

MODELO UNICO
UNICO MODEL | MODÈLE UNICO

Kit composto por:

- Aro WPC
- Guarnição em WPC
- Pelúcia JM2 6mm
- Vedante acústico em borracha 552

Frame kit includes:

- WPC jambs
- WPC architraves
- Pile JM2 6mm
- Rubber acoustic seal 552

Kit composé par:

- Huisserie WPC
- Chambranles en WPC
- Joints brosses JM2 6mm
- Joint acoustique en caoutchouc 552

L	Max. 2000	H	Max. 2700
E	96 116 136 156 176 196		



Porta de madeira | Wooden door | Porte en bois

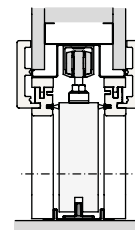
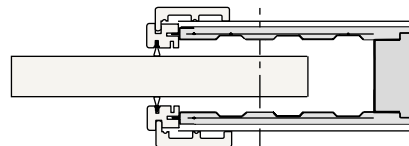
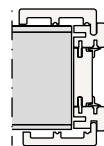

Porta de vidro | Glass door | Porte en verre

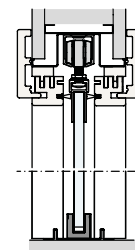
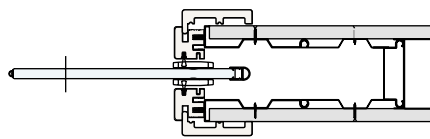
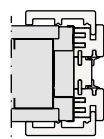

Nos caixilho com porta de correr em vidro, a altura livre é menor 60 mm que a altura standard.

*In pocket frames with glass doors, the clear height has 60 mm less than those with wooden doors.
La passage libre des caissons avec des portes en verre perd 60 mm d'haute en relation aux caissons avec des portes en bois.*

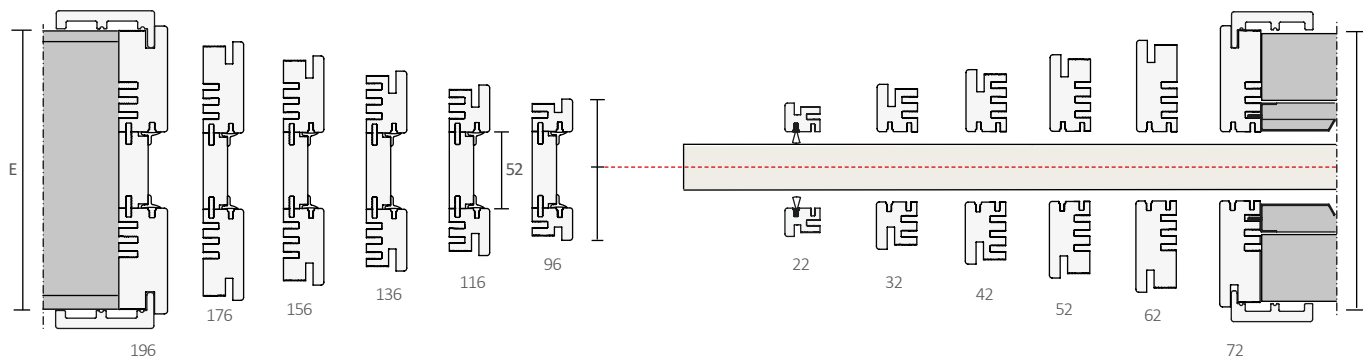

Como escolher o aro indicado para a sua porta de correr | How to choose the right door frame for your sliding door | Comment choisir le correct huisserie pour votre porte coulissante

ESPESSURA CAIXILHO THICKNESS POCKET ÉPAISSEUR DU CAISSON	TIPO DE PAREDE WALL TYPE TYPE DE MUR	ACABAMENTO WALL FINISHING FINITION	ESPESSURA FINAL DE PAREDE FINISHED WALL THICKNESS ÉPAISSEUR DU MUR FINI
70	Gesso cartonado Drywall Plaques de plâtre	1 placa de cada lado 1 sheet per side 1 plaque par côté	96
70	Gesso cartonado Drywall Plaques de plâtre	2 placas de cada lado 2 sheets per side 2 plaques par côté	122
70	Alvenaria Masonry Enduit	Tijolo de 70mm + reboco 70mm brick + masonry Brique de 70mm + enduit	96
70	Alvenaria Masonry Enduit	Tijolo de 70mm + reboco + Azulejo 70mm brick + masonry + tiles Brique de 70mm + enduit + carrelage	110- 120
90	Gesso cartonado Drywall Plaques de plâtre	1 placa de cada lado 1 sheet per side 1 plaque par côté	116
90	Gesso cartonado Drywall Plaques de plâtre	2 placas de cada lado 2 sheets per side 2 plaques par côté	142
90	Alvenaria Masonry Enduit	Tijolo de 90mm + reboco 90mm brick + masonry Brique de 90mm + enduit	120
90	Alvenaria Masonry Enduit	Tijolo de 90mm + reboco + Azulejo 90mm brick + masonry + tiles Brique de 90mm + enduit + carrelage	130 - 140
90	Alvenaria Masonry Enduit	Tijolo de 110mm + reboco 110mm brick + masonry Brique de 110mm + enduit	140
90	Alvenaria Masonry Enduit	Tijolo de 110mm + reboco + Azulejo 110mm brick + masonry + tiles Brique de 110mm + enduit + carrelage	150- 160
90	Alvenaria Masonry Enduit	Tijolo de 150mm + reboco 150mm brick + masonry Brique de 150mm + enduit	170
90	Alvenaria Masonry Enduit	Tijolo de 150mm + reboco + Azulejo 150mm brick + masonry + tiles Brique de 150mm + enduit + carrelage	180-190

NOTA | NOTE: Para caixilhos OPENSACE centrados na parede com porta em madeira | For wall centered OPENSACE pocket frames | Pour des contre-châssis OPENSACE centrés au mur

ARO EM CONTRAPLACADO PARA PORTA DE CORRER | PLYWOOD FRAME FOR SLIDING DOOR
HUISSERIE EN CONTREPLAQUÉ POUR PORTE COULISSANTE

MODELO PARALELO
PARALELO MODEL | MODÈLE PARALELO

Kit composto por:
Aro em contraplacado
Guarnições WPC ajustáveis
Pelúcia
Vedante acústico em borracha

Frame kit includes:
Plywood frame
WPC adjustable architraves
Pile
Rubber acoustic seal

Kit composé par:
Huisserie en contreplaqué
Chambranles WPC réglables
Jointts brosses
Joint acoustique en caoutchouc



Porta de madeira | Wooden door | Porte en bois

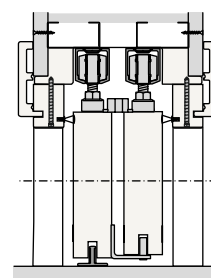
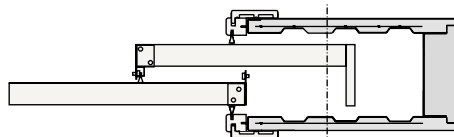
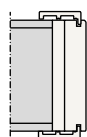

Porta de vidro | Glass door | Porte en verre

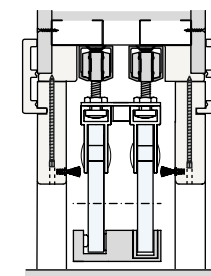
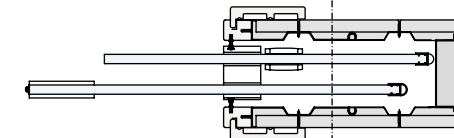
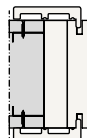

MODELO INVERSO
INVERSO MODEL | MODÈLE INVERSO

Kit composto por:
Aro em contraplacado
Guarnições WPC ajustáveis
Pelúcia
Batente em borracha.

Frame kit includes:
Plywood frame
WPC Adjustable architraves
Pile
Rubber seals

Kit composé par:
Huisserie en contreplaqué
Chambranles WPC réglables
Jointts brosses
Jointts butées



Porta de madeira | Wooden door | Porte en bois

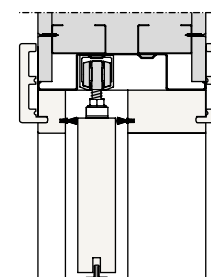
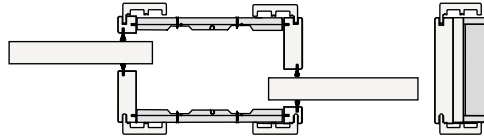
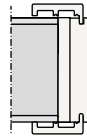

Porta de vidro | Glass door | Porte en verre

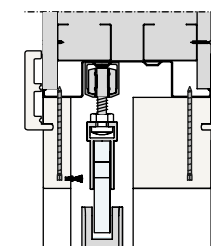
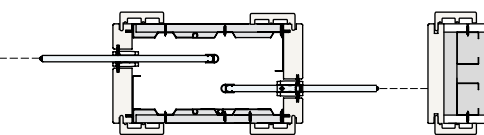
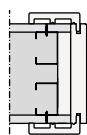

Madeira
Wood
Bois



Vinyl
Vinyl
Vinyl



Lacados
Lacquered
Laqués



Espessura da porta
Door thickness
Épaisseur de la porte



Espessura da porta de vidro
Glass door thickness
Épaisseur de la porte de verre

Dimensões em milímetros
Dimensions in millimeters
Dimensions en millimètres



ARO EM ALUMÍNIO COM GUARNIÇÃO DE 50 OU 70 MM | ALUMINIUM FRAME WITH 50 OR 70 MM ARCHITRAVES
HUISSERIE EN ALUMINIUM AVEC DES CHAMBRANLES DE 50 OU 70 MM

GUARNIÇÕES (P) ARCHITRAVES CHAMBRANLES	CAIXILHO 70 POCKET FRAME 70 CAISSON 70		CAIXILHO 90 POCKET FRAME 90 CAISSON 90	
	MIN	MAX	MIN	MAX
30	100	115**	120	135**
50	140	150**	160	170**
70	180	190**	200	210**
90	220	230**	240	250**
110	260	270**	280	290**
130	300	310**	320	330**
150	340	350**	360	370**
170	380	390**	400	410**

** Para as espessuras intermedias entre os intervalos definidos na tabela, será necessário refiar os perfis das guarnições do intervalo superior.

** For non-existing intermediate thicknesses in the table, it will be necessary to cut the tenon side of the architrave of the upper range in order to fit the desired size.

** Pour les épaisseurs intermédiaires inexistantes dans le tableau, il sera nécessaire de couper la languette des moulures de l'intervalle supérieure.

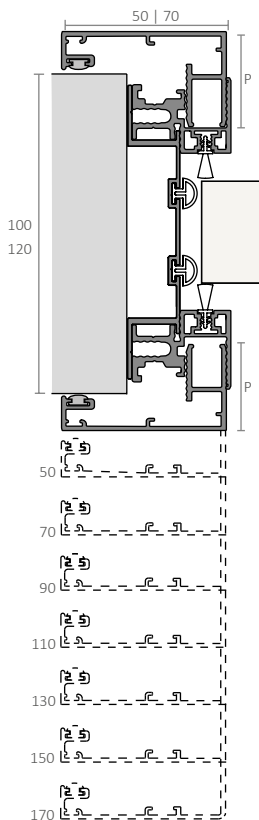

ARO PARA PORTA DE CORRER EM MADEIRA
WOODEN SLIDING DOOR FRAME | HUISSERIE POUR PORTE COULISSANTE EN BOIS

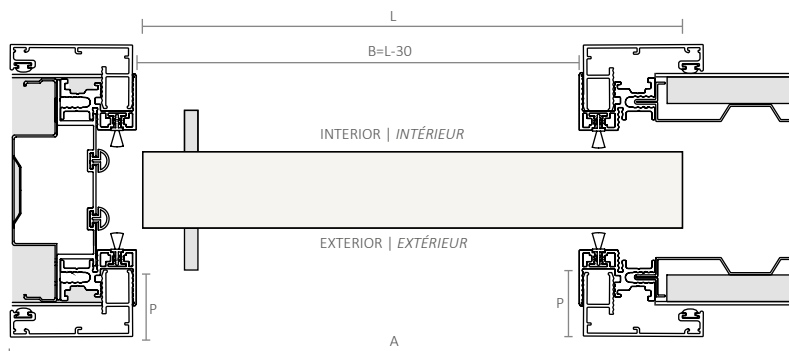

Aro com cabeça
 Door frame with head
 Huisserie avec traverse haute

A = 2xL+60

C = H+70

Aro sem Cabeça
 Without header
 Sans traverse haute

A = 2xL+60

H = C-12

ARO PARA PORTA DE CORRER EM VIDRO
GLASS SLIDING DOOR FRAME | HUISSERIE POUR PORTE COULISSANTE EN VERRE

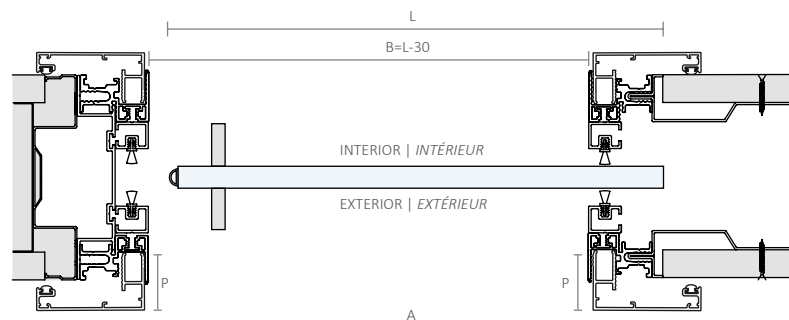

Aro com cabeça
 Door frame with head
 Huisserie avec traverse haute

A = 2xL+60

C = H+70

Aro sem Cabeça
 Without header
 Sans traverse haute

A = 2xL+60

H = C-12

Corte vertical com porta de madeira
 Vertical cut with wooden door | Coupe verticale avec porte en bois

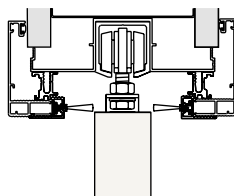

CAIXILHO 70
 POCKET FRAME 70
 CAISSON 70

Porta | Door | Porte



Corte vertical com porta de vidro
 Vertical cut with glass door | Coupe verticale avec porte en verre

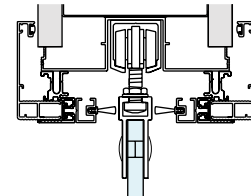

CAIXILHO 90
 POCKET FRAME 90
 CAISSON 90

Porta | Door | Porte





ARO DESIGN PARA PORTA DE CORRER

DESIGN DOOR FRAME FOR SLIDING DOOR
HUISSERIE DESIGN POUR PORTE COULISSANTE

EXTENSÕES (P) EXTENSIONS EXTENSIONS	CAIXILHO 70 POCKET FRAME 70 CAISSON 70	CAIXILHO 90 POCKET FRAME 90 CAISSON 90
	MIN MAX	MIN MAX
-	100	120
30	128 138**	148 158**
45	158 168**	178 188**
60	188 198**	208 218**
75	218 228**	238 248**
87,5	243 253**	263 273**
120	308 318**	328 338**

** Para as espessuras intermédias entre os intervalos definidos na tabela, será necessário refiar os perfis das guarnições do intervalo superior.

** For non-existing intermediate thicknesses in the table, it will be necessary to cut the tenon side of the architrave of the upper range in order to fit the desired size.

** Pour les épaisseurs intermédiaires inexistantes dans le tableau, il sera nécessaire de couper la languette des moulures de l'intervalle supérieure.

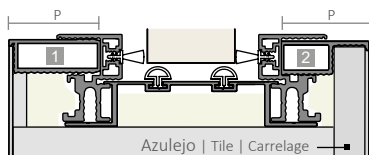

EXTENSÃO DESIGN

Design extensions | Extensions design

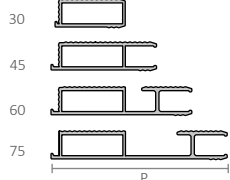

EXTENSÃO DESIGN UNIVERSAL

Universal design extensions | Extensions design universal

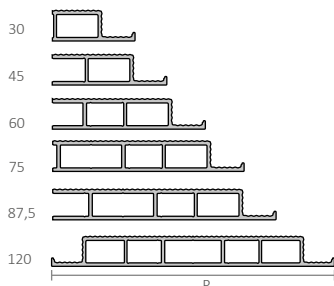

Adequado para paredes revestidas a azulejo
Suitable for tiled walls | Approprié pour des murs revêtus à carrelage

ARO PARA PORTA DE CORRER EM MADEIRA

WOODEN SLIDING DOOR FRAME | HUISSERIE POUR PORTE COULISSANTE EN BOIS

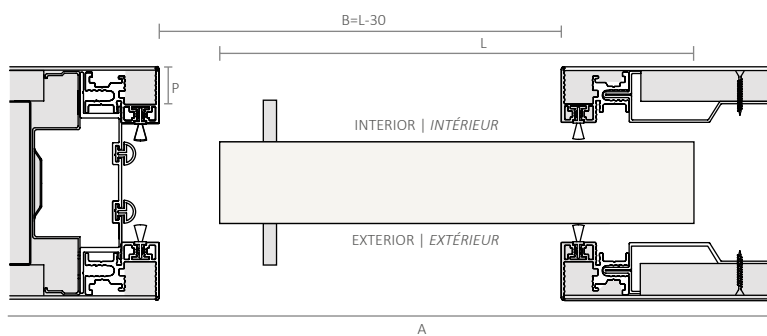

Aro com cabeça
Door frame with head
Huisserie avec traverse haute

A = 2xL+60
C = H+76

Aro sem Cabeça
Without header
Sans traverse haute

A = 2xL+60
H = C-12

ARO PARA PORTA DE CORRER EM VIDRO

GLASS SLIDING DOOR FRAME | HUISSERIE POUR PORTE COULISSANTE EN VERRE

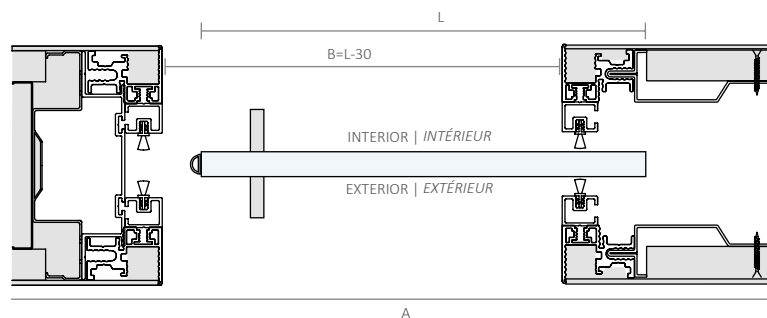

Aro com cabeça
Door frame with head
Huisserie avec traverse haute

A = 2xL+60
C = H+76

Aro sem Cabeça
Without header
Sans traverse haute

A = 2xL+60
H = C-12

Corte vertical com porta de madeira
Vertical cut with wooden door | Coupe verticale avec porte en bois

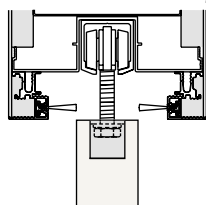

CAIXILHO 70
POCKET FRAME 70
CAISSON 70

Porta | Door | Porte

35 | 40



35 | 40 | 45

Corte vertical com porta de vidro
Vertical cut with glass door | Coupe verticale avec porte en verre

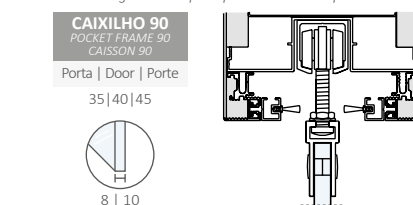

CAIXILHO 90
POCKET FRAME 90
CAISSON 90

Porta | Door | Porte

35 | 40 | 45



8 | 10



Espessura da porta de madeira
Wood door thickness
Épaisseur de la porte Bois



Espessura da porta de vidro
Glass door thickness
Épaisseur de la porte de verre

Dimensões em milímetros
Dimensions in millimeters
Dimensions en millimètres

open[®]space[®]

sliding doors by GOSIMAT



Rua do Olival, 499- Marrazes 2415-527
Leiria- PORTUGAL

t. +351 244 882 596 f. +351 244 881 318
+351 244 849 210 m. +351 919 728 210
GPS Lat. 39.762310º Long. -8.815820º
geral@gosimat.pt www.gosimat.pt



OPENSACE é uma marca registada da GOSIMAT
OPENSACE is a GOSIMAT trademark | OPENSACE est une marque de GOSIMAT

Todos os direitos reservados. A reprodução total ou parcial do conteúdo deste catálogo é proibida.

All rights reserved. Any unauthorized reproduction of this content, in part or whole, is strictly prohibited. | Tous droits réservés. La reproduction totale ou partielle du contenu de ce catalogue est strictement interdite.

GSdoors[®]
design solutions by gosimat

GSfloors[®]
flooring solutions by gosimat

GSconcept[®]
furniture and accessories by gosimat